

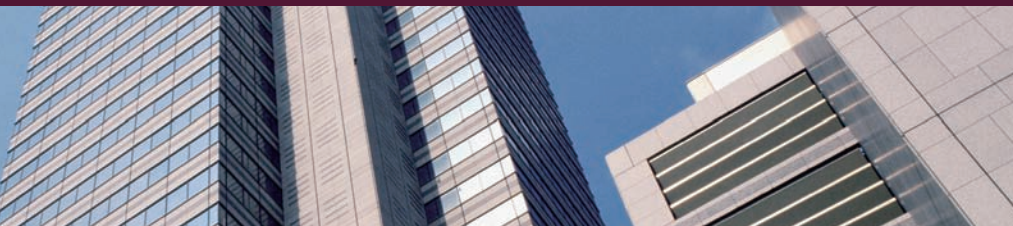

PLEASE NOTE THERE IS AN ERROR ON PAGE 13
UNDER THE HEADING "HIGH COPs".
The comparison description in the graph should read:
Cooling operation 8 class (22kW)
Heating operation 8 class (22kW)

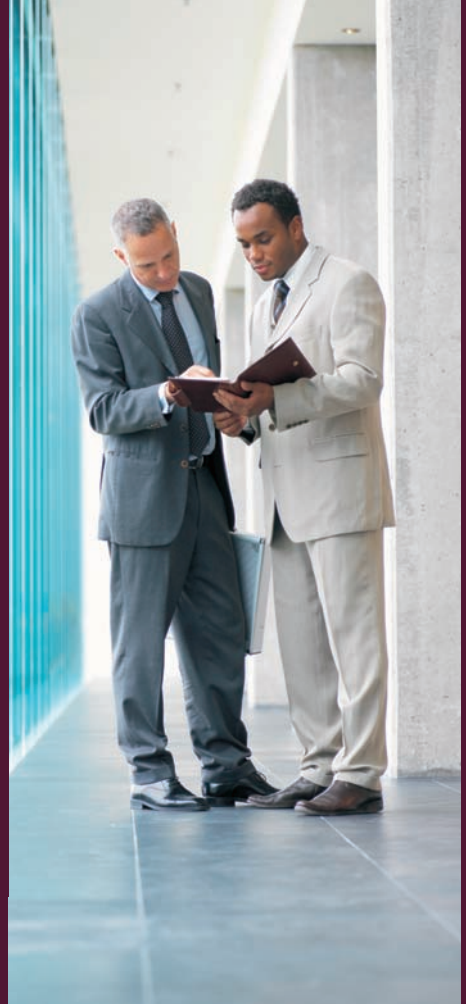

Cooling Only/Heat Pump
50 Hz



A system with the high capacity needed to suit large-sized buildings

R-410A

Benefits for
property **OWNERS**

With Daikin's proprietary inverter technology and cutting-edge control technology for refrigerant, the VRV8 air conditioning system operates with outstanding efficiency. This contributes to high energy savings, which greatly reduces your running costs and facilitates far better building management.



VRV8 Latest individual air conditioning technology adds new real value to today's buildings

Benefits for **INSTALLERS**

Daikin offers a compact design for VRV8 outdoor units by further optimising equipment functions, exceeding the norm for air conditioning systems. Compact units facilitate installation in limited areas, such as rooftops, and take up less effective space. Easier installation work realises fast completion with time to spare.



Benefits for **USERS**

To provide a comfortable air environment, Daikin offers air treatment systems beyond mere air conditioning. As well as bringing air to a comfortable temperature, the air quality can be treated with ventilation, humidification, and other processes. Ease of use is realised through advanced, centralised control systems.



Air conditioning systems that use new refrigerant and save energy are the norm. However, we at Daikin have gone much further by maximising our advanced technology developed over 30 years as the leading manufacturer of individual air conditioning systems. Not only top level air conditioning performance, we also offer minimal space utilisation, efficient building management and a multitude of other added value features.

Benefits for **CONSULTANT** and **DESIGN OFFICES**

Daikin's VRV systems include indoor and outdoor units available in a wide range of models for various building sizes and installation conditions. Long refrigerant piping lengths and other features put few restrictions on design for great flexibility in meeting the needs of the building.



VRVⅢ — Developed to facilitate more

Daikin proudly introduces the VRVⅢ series, which is well-suited to large-sized buildings. This air conditioning system provides outdoor units that extend air conditioning capacity up to 54 class (147 kW). It also incorporates numerous outstanding features, such as a wide range of outdoor and indoor units, longer actual and total piping length, and high external static pressure. The VRVⅢ series provides the power and versatility you need for flexible design and easy installation in large-sized buildings.

flexible system design in large-sized buildings

- Outdoor units with large capacities.....page 7
- Wide range and an increased number of connectable indoor units.....page 9
- Extended actual and total maximum piping length.....page 10
- Extended level difference between outdoor units and indoor units.....page 10
- High external static pressure.....page 11
- Two types of outdoor unit combinations.....page 11

Easier installation.....page 12

- Automatic test operation

A sense of responsibility.....page 13

- High COPs/Energy savings
- Compliant with the RoHS Directive
- Double backup operation in compressors and units
- Less possibility of refrigerant leakage

Enhanced comfort.....page 14

- Outdoor units designed for low-sound operation
- Efficient compressor
- Nighttime quiet operation function

Contents

Technologies.....page 5	Option List.....page 45
Main Features.....page 7	└ Indoor units.....page 45
Indoor Unit Lineup.....page 15	└ Outdoor units.....page 48
Outdoor Unit Lineup.....page 27	Control Systems.....page 49
Specifications.....page 29	Air Treatment Equipment Lineup....page 60
└ Indoor units.....page 29	└ Outdoor-air processing unit.....page 61
└ Outdoor units.....page 37	└ Heat Reclaim Ventilator with DX-coil and humidifier.....page 65
	└ Heat Reclaim Ventilator.....page 69

VRV III—Created to respond to the needs

Daikin's constant efforts have been devoted towards using the latest and most revolutionary technologies in the development of the VRV III system for large-sized buildings. The system offers larger outdoor capacities, greater energy savings, easier installation, longer actual and total piping, and more.

1 Improved fans and grilles

A higher external static pressure has been achieved—from 58.8 Pa to 78.4 Pa—thanks to reduced internal pressure loss, use of self developed fans and grilles.

Aero spiral fan and aero asymmetrical fan

The area of the fan blades has been increased and optimised for each casing. This greatly reduces pressure loss, resulting in a higher external static pressure.

Aero asymmetrical fan

The three-bladed fan on the 10 class (28 kW) unit, with a diameter of 700 mm, has been redesigned to include four blades and now has a diameter of 680 mm. Blade area has been increased by 25%.

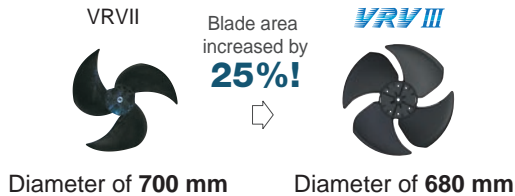

Aero spiral fan (Powerful Dual DC fan)

In the 14 and 16 class (40 and 45 kW) unit, a single fan with a diameter of 700 mm has been split into two fans with diameters of 540 mm each. Blade area has been increased by 20% to increase airflow.

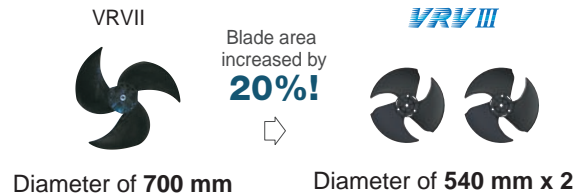

Aero smooth grille

The three-dimensional, integrated, soft woven steel grilles are covered with a plastic coating that protects them from rotating elements and the possibility of fire damage.

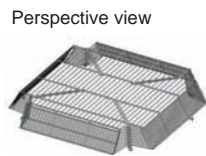

2 Heat exchanger

This heat exchanger contributes to a high COP because of an increase from 7% to 10% of the effective length as well as an optimised e-Pass heat exchanger.

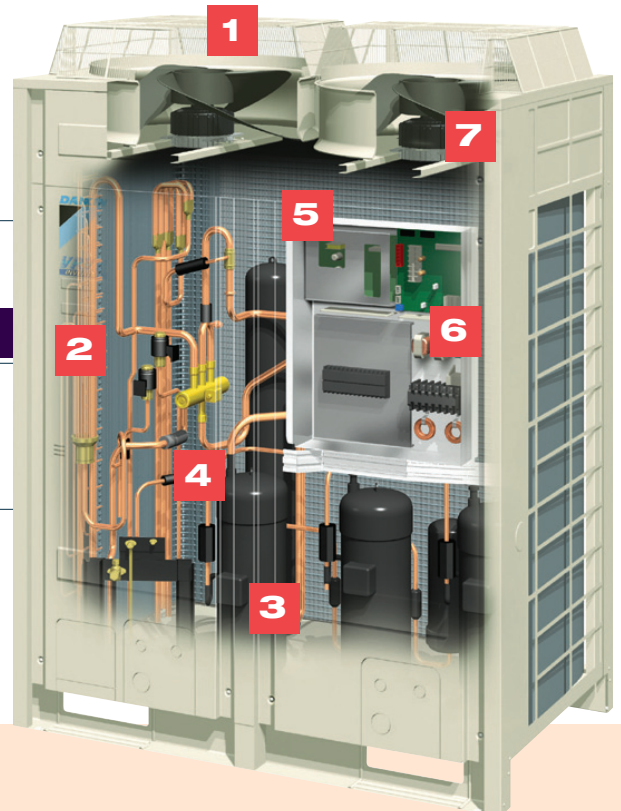



of large-sized buildings

3 Improving the high efficiency compressor to achieve a high COP and larger capacity

Reluctance DC scroll compressor

Daikin's unique scroll compressor reduces heat loss, and is driven by a high efficiency motor to achieve significant energy savings.

High torque and efficiency is attained with the adoption of neodymium magnets.

Powerful magnets

Use of neodymium magnets in the motor enables efficient generation of high torque.

Neodymium magnets are well known for their powerfulness compared to commonly used ferrite magnets.

Reluctance DC motor

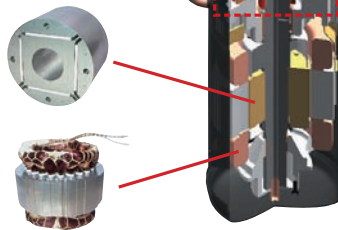

High-performance, low-noise scroll compressor operates at a faster rate. The speed increase has been achieved through advanced stress analysis for increased strength and utilisation of the advantages (oil film control) of the high thrust mechanism*.

*High thrust mechanism

By introducing high pressure oil, the reactive force from the fixed scroll is added to the internal force, thereby reducing thrust losses. This results in improved efficiency and suppressed sound levels.

4 Heat transfer circuit

By performing super cooling before the expansion process, the volume of refrigerant that needs to be circulated to the indoor units can be reduced without lowering the evaporation temperature. This permits the use of narrower piping.

6 Smooth sine wave DC Inverter

By adoption of the Sine Wave, which smoothes the rotation of the motor, operation efficiency is improved sharply.

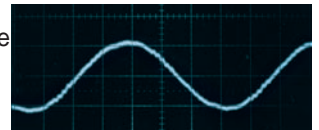

5 Compact aero box

Realises a compact casing by stacking the Inverter and control PCBs plus optimising the internal design to suit airflow speed. This achieves lower noise and reduces the power required by the large-diameter fanned outdoor unit.

7 DC fan motor

- Across entire range of models (from 5 to 54 class (from 14 to 147 kW)).
- Efficiency improvement by up to 40% especially at low speed.

DC fan motor structure

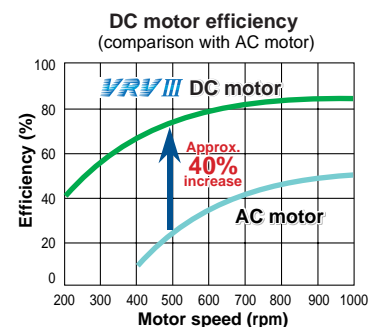

Note: Data are based on studies conducted under controlled conditions at a Daikin laboratory.

Major advances of the **VRV III** over the VRVII

The latest technology is implemented in the VRVIII system. Surpassing even the VRVII, the VRVIII responds to more of the needs of our customers that require air-conditioning solutions for large-sized buildings.

Large capacities for large-sized buildings

Outdoor units

- Offering a higher capacity of up to 54 class (147 kW), responding to the needs of large-sized buildings

The previous outdoor unit had a maximum output of 48 class (132 kW). The VRVIII has a top output of 54 class (147 kW)! By connecting main units (up to 18 class (49 kW) each), a high-capacity system (up to 54 class (147 kW)) that is compact yet flexible can be achieved.

VRVII
MA series

48 class
(132 kW)



VRV III

**54 class
(147 kW)**

5 class



New

6, 8, 10 class



12, 14, 16, 18 class



20, 22, 24, 26, 28 class



30, 32, 34, 36 class



38, 40, 42, 44, 46 class



48, 50, 52, 54 class



New

- New 6 class (6 kW) model

New 6 class (6 kW) model is added to the lineup of VRVIII outdoor units.

* Refer to page 28 for combination details.















for large-sized buildings



Large capacities for large-sized buildings

Indoor units

Daikin's indoor unit system offers a large number of connectable indoor units—64! Furthermore, our wide range of indoor units includes 15 types and 83 models to meet the needs of customers.

Type	Model Name	Capacity Range	20	25	32	40	50	63	80	100	125	140	145	180	200	250	
			Capacity Index	2.2 kW	2.8 kW	3.6 kW	4.5 kW	5.6 kW	7.1 kW	9 kW	11.2 kW	14 kW	16 kW	16.2 kW	20 kW	22.4 kW	28 kW
			Capacity Index	20	25	31.25	40	50	62.5	80	100	125	140	145	180	200	250
Ceiling Mounted Cassette (Round Flow)	FXFQ-PVE			●	●	●	●	●	●	●	●						
Ceiling Mounted Cassette (Compact Multi Flow)	FXZQ-MVE		●	●	●	●	●										
Ceiling Mounted Cassette (Double Flow)	FXCQ-MVE		●	●	●	●	●	●	●		●						
Ceiling Mounted Cassette Corner	FXKQ-MAVE			●	●	●		●									
Slim Ceiling Mounted Duct	FXDQ-PBVE (700 mm width type)		●	●	●												
	FXDQ-NBVE (900/1,100 mm width type)					●	●	●									
Ceiling Mounted Built-in	FXSYQ-MVE		●	●	●	●	●	●	●	●	●						
Ceiling Concealed (Duct)	FXDYQ-M(A)V1								●	●	●		●	●	●	●	
Ceiling Mounted Duct	FXMQ-PVE		●	●	●	●	●	●	●	●	●	●					
	FXMQ-MAVE														●	●	
Ceiling Suspended	FXHQ-MAVE				●			●		●							
Wall Mounted New	FXAQ-PVE		New	New	New	New	New	New									
Floor Standing	FXLQ-MAVE		●	●	●	●	●	●									
Concealed Floor Standing	FXNQ-MAVE		●	●	●	●	●	●									

Note: R-410A VRV system indoor units are not compatible with the R-22 VRV system.

Connection unit series indoor units (For heat pump models only)

Type	Model Name	Capacity Range	20	25	32	40	50	71	100	125	
			Capacity Index	2.2 kW	2.8 kW	3.6 kW	4.5 kW	5.6 kW	8 kW	11.2 kW	14 kW
			Capacity Index	20	25	31.25	40	50	71	100	125
			Connection Unit	—						BEVQ71MAVE	BEVQ100MAVE
Ceiling Suspended Cassette	FXUQ-MAV1								●	●	●

Note: BEV units are necessary for Connection unit series indoor units. Refer to the Engineering Data Book for details.

Large capacities for large-sized buildings

An increased number of connectable indoor units

The number of connectable indoor units has been drastically increased from 40 to 64!

Increased indoor unit connections

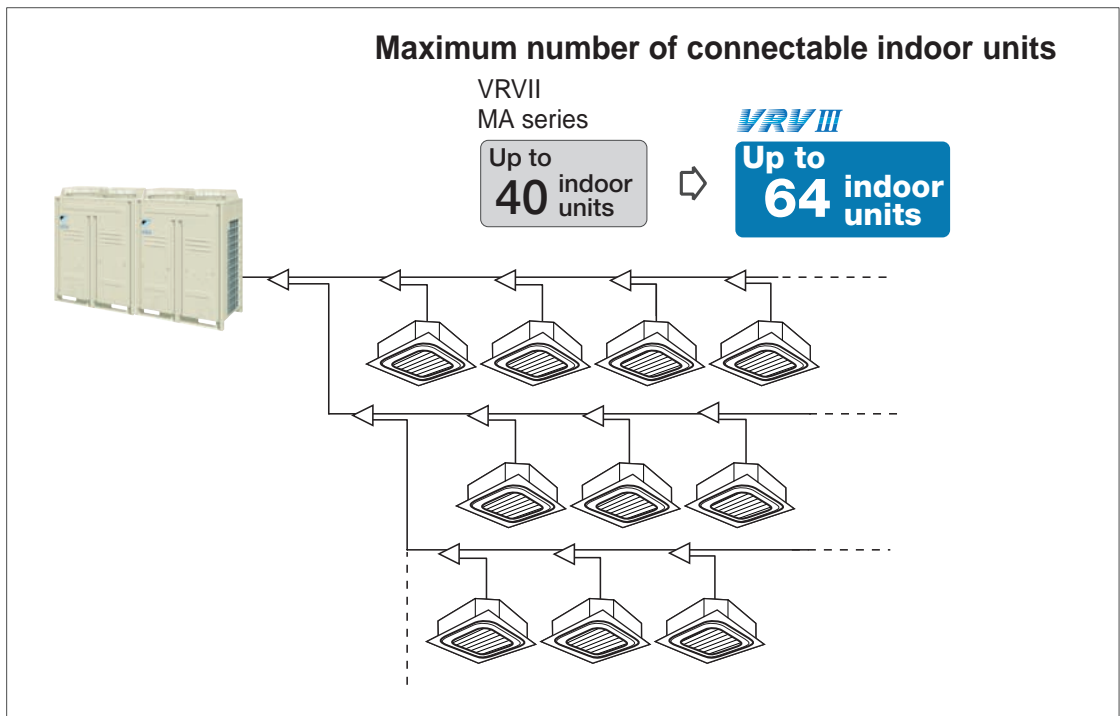

Refer to page 28 for the maximum number of connectable indoor units.

Connection ratio

Connection capacity at maximum is 200%.

Connection ratio

50%—200%*

*Connection ratio for RXYQ6PA is 70 - 200%.

Connection ratio =

$$\frac{\text{Total capacity index of the indoor units}}{\text{Capacity index of the outdoor units}}$$

Conditions of indoor unit connection capacity

Applicable indoor units	 FXDQ, FXSYQ, FXMQ-P, FXAQ models	Other indoor unit models*
Single outdoor units	200%	200%
Double outdoor units		160%
Triple outdoor units		130%

* For the FXFQ25 models, maximum connection ratio is 130% for the entire range of outdoor units.

Note: If the operational capacity of indoor units is more than 130%, low airflow operation is enforced in all the indoor units.



Large capacities for large-sized buildings

Extended long piping length

Piping length is drastically extended! The long piping length provides more design flexibility, which can match even large-sized buildings.

Max. actual piping length

VRVII MA series

VRV III

150 m



165 m

Max. equivalent piping length

VRVII MA series

VRV III

175 m



190 m

Max. total piping length

VRVII MA series

VRV III

510 m



1000 m

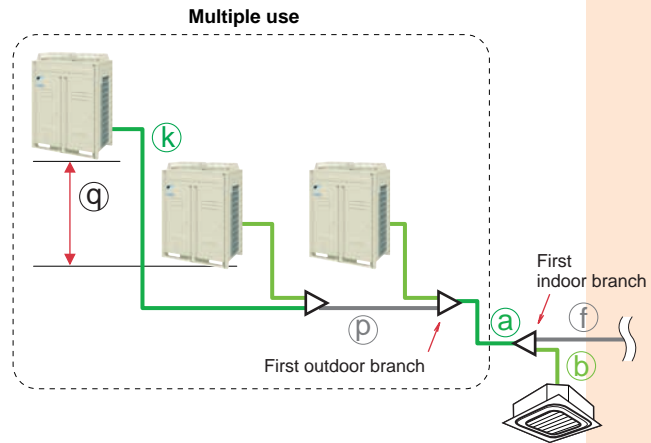

Max. level difference between the outdoor units and the indoor units

VRV III

RX(Y)Q8PA-54PA

Outdoor unit above indoor unit:

90 m^{*2}

VRVII MA series

Outdoor unit above indoor unit:

50 m

Outdoor unit below indoor unit:

40 m

Outdoor unit below indoor unit:

90 m

RX(Y)Q5,6PA

Outdoor unit above indoor unit:

50 m

Outdoor unit below indoor unit:

40 m

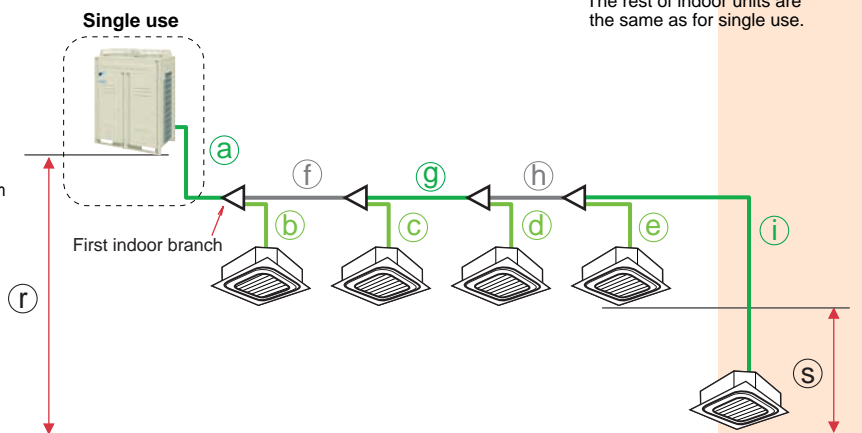

*The rest of indoor units are the same as for single use.

Colours in the diagram above are merely for identifying pipes referenced with symbols such as @.

		Actual piping length	Example	Equivalent piping length	
Maximum allowable piping length	Refrigerant piping length	165 m	a+f+g+h+i	190 m	
	Total piping length	1000 m	a+b+c+d+e+f+g+h+i	—	
	Between the first indoor branch and the farthest indoor unit	90 m ^{*1}	f+g+h+i	—	
	Between the outdoor branch and the last outdoor unit	10 m	k+p	13 m	
Maximum allowable level difference			Level Difference	Example	Outdoor Units
	Between the outdoor units (Multiple use)		5 m	q	RX(Y)Q8PA-54PA
	Between the indoor units		15 m	s	—
	Between the outdoor units and the indoor units	If the outdoor unit is above.	90 m ^{*2}	r	RX(Y)Q8PA-54PA
		If the outdoor unit is below.	90 m	r	
		If the outdoor unit is above.	50 m	r	RX(Y)Q5,6PA
If the outdoor unit is below.		40 m	r		

* 1. No special requirements up to 40 m. The maximum actual piping length can be 90 m, depending on conditions. Various conditions and requirements have to be met to allow utilisation of 90 m piping length. Be sure to refer to the Engineering Data Book for details of these conditions and requirements.

* 2. Level differences above 50 m are not supported by default but are available on request for RX(Y)Q8PA-54PA (If the outdoor unit is above the indoor unit).

Large capacities for large-sized buildings

High external static pressure 78.4 Pa (8 mm H₂O)

Higher external static pressure has been achieved thanks to the fan grilles and the dual DC fans that reduce internal pressure loss. Exceeding the previous 58.8 Pa (6 mm H₂O) level, Daikin now offers 78.4 Pa (8 mm H₂O) external static pressure by field setting to meet the requirements for installation on each floor, often requested for large-sized buildings.

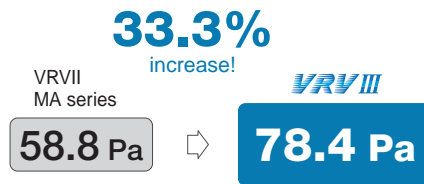

Selectable from two types of combinations

Standard model (Space saving type)

class Single unit	Single outdoor units								Double outdoor units			
	5	6	8	10	12	14	16	18	20	22	24	26
5	●											
6		●										
8			●						●		●	●
10				●						●		
12					●				●	●		
14						●						
16							●				●	
18								●				●
Total number of connected outdoor units	1	1	1	1	1	1	1	1	2	2	2	2

High efficiency model (Energy saving type)

class Single unit	Double outdoor units		Triple outdoor units							
	16	18	24	26	28	30	32	34	36	38
8	●●	●	●●●	●●	●●	●	●			
10		●		●		●		●		
12					●	●	●●	●●●	●●●	●●
14										●
16										
18										
Total number of connected outdoor units	2	2	3	3	3	3	3	3	3	3



Easier installation

Automatic test operation

Simply press the test operation button and the unit performs an automatic system check, including wiring, shutoff valves, and sensors. The results are returned automatically after the check finishes.

Double outdoor units						Triple outdoor units									
28	30	32	34	36		38	40	42	44	46	48	50	52	54	
						●	●	●	●						
●										●					
	●					●					●				
												●			
		●●	●				●●	●					●		
●	●		●	●●		●		●	●●	●●	●●	●●	●●	●●●	
2	2	2	2	2		3	3	3	3	3	3	3	3	3	

* Refer to page 28 for outdoor combination details.

Triple outdoor units						
40	42	44	46	48	50	
●●	●●	●	●			
●		●●	●	●●●	●●	
	●		●		●	
3	3	3	3	3	3	

* Refer to page 28 for outdoor combination details.

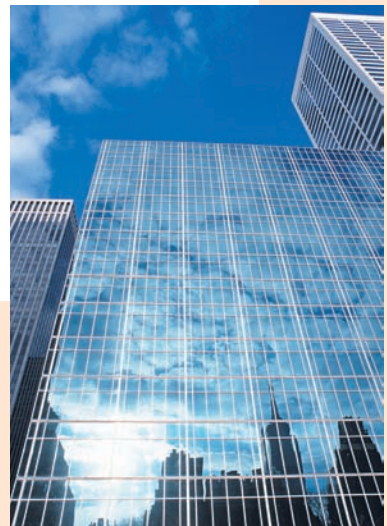

A sense of responsibility

High COPs

It has become essential for air conditioning manufacturers to develop systems that provide high energy savings. We at Daikin have made great efforts in this field, and the VRVIII delivers highly efficient performance, contributing to high energy savings.

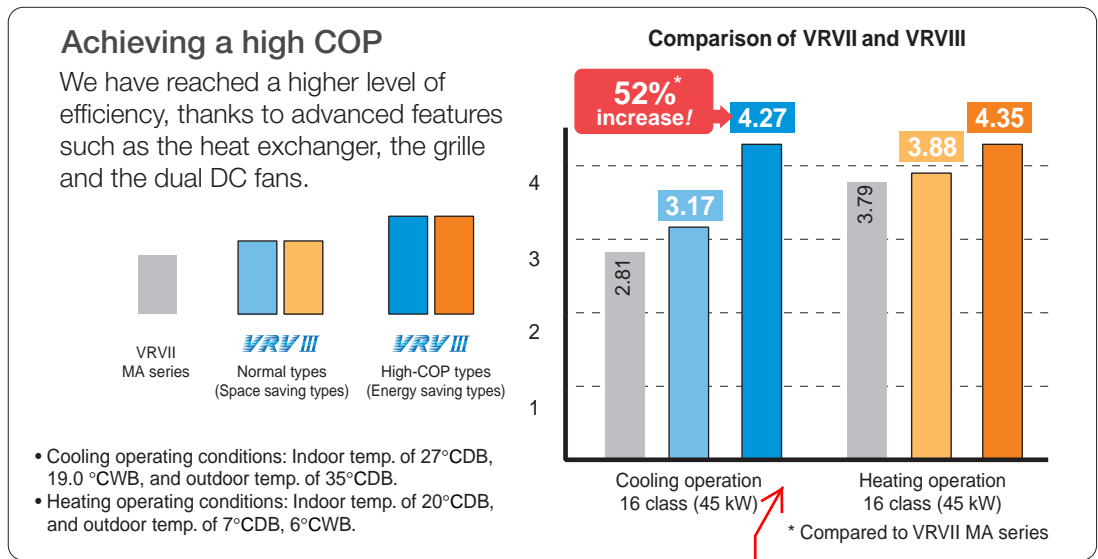

Compliant with the RoHS Directive*

Should read: Cooling operation 8 class (22kW)
Heating operation 8 class (22kW)

We have been making efforts to facilitate the transition to using RoHS Directive*-compliant materials for system parts.

* RoHS Directive

The RoHS (Restriction of Hazardous Substances (in electrical and electronic equipment)) Directive is an environmental directive enacted to regulate the use of designated chemical substances (lead, cadmium, hexavalent chromium, mercury, polybrominated biphenyls and polybrominated diphenylether) in electrical equipment. All household products subject to this Directive and sold in Europe from July 1, 2006 are legally bound to comply with the RoHS Directive.

Double backup operation in compressors and units

- If one of the multiple compressors in a single outdoor unit system malfunctions, the other compressors take over emergency operation.^{*1}
- If one of the unit in a multiple outdoor system malfunctions, the other outdoor units provide emergency operation^{*2} until repairs can be made.

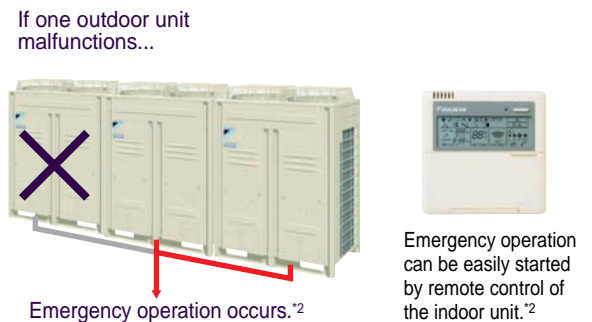
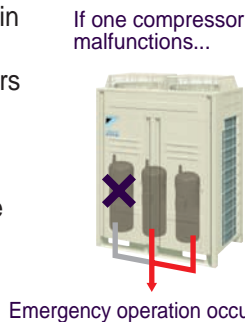

*1. Possible only with single outdoor unit systems that are equipped with two or more compressors. Local setting of the outdoor unit is necessary.
*2. For systems composed of two or more outdoor units

Less possibility of refrigerant leakage

Conventionally, shutoff valve connections are flanged or flared. In the VRVIII system, the connections for all outdoor units are brazed, meaning less possibility of refrigerant leakage.



Enhanced comfort

Outdoor units designed for low-sound operation

Outdoor units created with cutting-edge technologies provide quiet operation to increase users' comfort.

Efficient compressor

High-performance, low-noise scroll compressor operates at a faster rate, reducing start-up time. This helps the unit to bring the room temperature up to the set level quickly.



Nighttime quiet operation function

Operation sound level selectable from 3 steps for the night mode

Mode 1. Automatic mode

Set on the outdoor PCB. Time of maximum temperature is memorised. The low operating mode will initiate 8 hours^{*1} after the peak temperature in the daytime, and normal operation will resume 10 hours^{*2} after that. The operation sound level for the night mode can be selected from 55 dB(A) (Step 1), 50 dB(A) (Step 2) and 45 dB(A) (Step 3). (For a single outdoor unit.)

Mode 2. Manual mode

Starting time and ending time can be input. (An external control adaptor for outdoor unit, DTA104A53/61/62, and a locally obtained timer are necessary.)

Mode 3. Combined mode

Combinations of modes 1 and 2 can be used depending on your needs.

*1. Initial setting. Can be selected from 6, 8 and 10 hours.

*2. Initial setting. Can be selected from 8, 9 and 10 hours.

Mode 1. Automatic mode

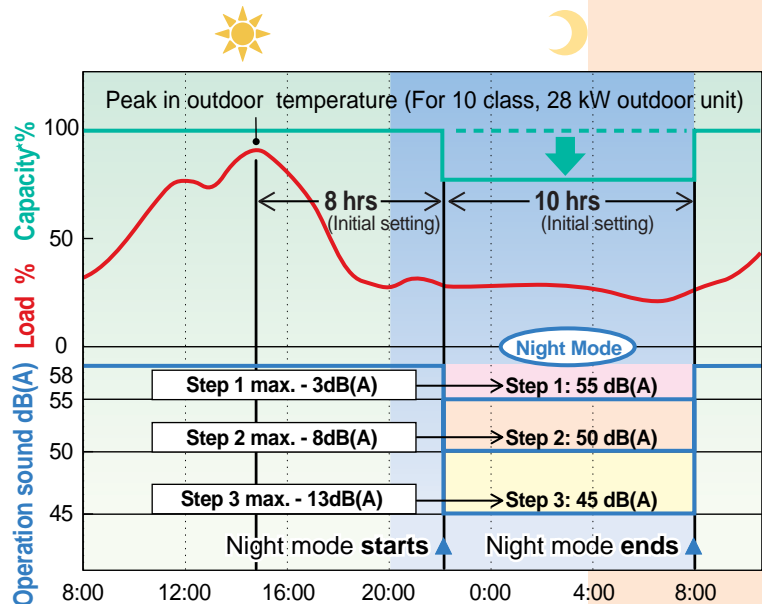

Note: • This function is available in setting at site.

• The relationship of outdoor temperature (load) and time shown in the graph is just an example.

* The capacity reduction rate differs depending on the operation sound level step selected.

Ceiling Mounted Cassette (Round Flow) Type

FXFQ25P/FXFQ32P/FXFQ40P
 FXFQ50P/FXFQ63P/FXFQ80P
 FXFQ100P/FXFQ125P



360° airflow improves temperature distribution and offers a comfortable living environment.

- The industry's first* Round Flow Ceiling Mounted Cassette type offers 360° airflow with improved temperature distribution.

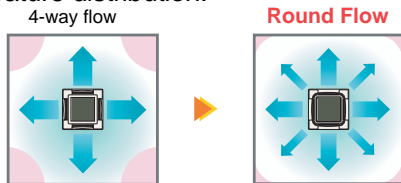

There are areas of uneven temperature.

There are much fewer areas of uneven temperature.

* As of April 2004, the release date for Japan.

- All models are lighter than the conventional ones.

Ex: Models FXFQ25P-50P are 4.5 kg lighter (reduced from 24 kg to 19.5 kg).

- Drain pump is equipped as standard accessory, and the lift height has been improved from 750 mm to 850 mm.

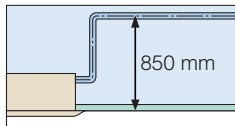

- A modern sophisticated decoration panel has been applied, with a panel surface that has been treated with a dirt-repellant coating.

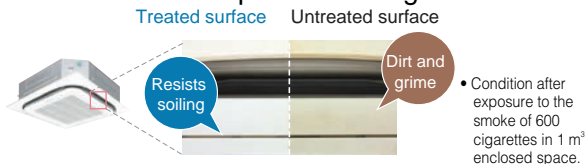

- An antibacterial treatment that uses silver ions has been applied to the drain pan, preventing the growth of slime, mould and bacteria that cause blockages and odours.
- The horizontal louvres prevent dew condensation. Their non-flocking surfaces, which repel dirt, are easy to clean.
- The air filter has an anti-mould and antibacterial treatment that prevents the growth of mould generated from dust or moisture that may adhere to the filter.

- Control of the airflow rate has been improved from 2-step to 3-step control.

- Low operation sound level (dB(A))

FXFQ-P	25/32	40	50	63	80	100	125
Sound level (HH/H/L)	30/28.5/27	31/29/27	32/29.5/27	34/31/28	36/33.5/31	43/37.5/32	44/39/34

- Example of airflow patterns: 360° airflow is available, as well as 2- to 4-way flows, so you can choose the most suitable airflow pattern depending on location or room layout.



Note: Whatever the discharge direction, the same type of panel is used. If installing for other than all-round flow, an air discharge outlet sealing member (option) must be used to close each unused outlet.

Ceiling Mounted Cassette (Compact Multi Flow) Type

FXZQ20M/FXZQ25M
FXZQ32M/FXZQ40M
FXZQ50M



Quiet, compact, and designed for user comfort

- Dimensions correspond with 600 mm × 600 mm architectural module ceiling design specifications.

- Low operation sound level

(240 V)(dB(A))

FXZQ-M	20/25	32	40	50
Sound level (H/L)	32/26	34/28	37/29	42/35

- Comfortable airflow

1 Wide discharge angle: 0° to 60°

- Auto swing

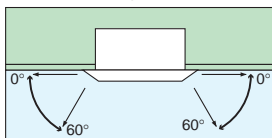

- Fixed angles: 5 levels

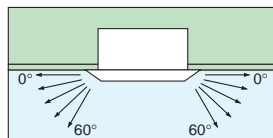

*Angles can be also set on site to prevent drafts (0°-35°) or soiling of the ceiling (25°-60°), other than standard setting (0°-60°).

2 2-, 3-, and 4-way airflow patterns are available, enabling installation in the corner of a room.

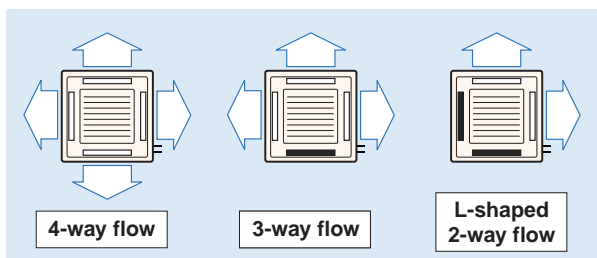

* For 3-way or 2-way flow installation, the sealing member for air discharge outlet (option) must be used to close each unused outlet.



- Drain pump is equipped as standard accessory with 750 mm lift.

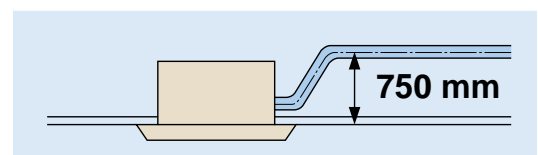

Ceiling Mounted Cassette (Double Flow) Type

FXCQ20M/FXCQ25M/FXCQ32M
 FXCQ40M/FXCQ50M/FXCQ63M
 FXCQ80M/FXCQ125M



Thin, lightweight, and easy to install in shallow ceiling spaces

- The low profile unit (only 305 mm high) can be installed in a ceiling space as shallow as 350 mm. All models feature a compact design with a depth of only 600 mm.

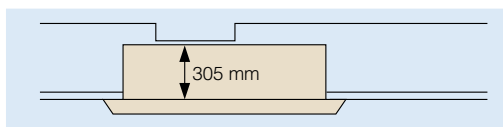

(When a high-efficiency filter is attached, the unit's height is 400 mm.)

- Low operation sound level (240 V)(dB(A))

FXCQ-M	20	25/32	40/50	63	80	125
Sound level (H/L)	34/29	36/30	37/32	39/34	41/36	46/40

- Designed with higher airflow suitable for high ceiling application up to 3 metres.
- Providing 2 different settings of standard and ceiling soiling prevention, the auto swing mechanism achieves even distribution of airflow and room temperature.
- Drain pump is equipped as standard accessory with 600 mm lift.

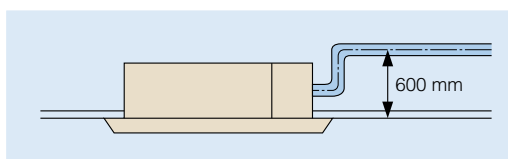

- Two types of optional high-efficiency filter are available (65% and 95%, colourimetric method).
- A long-life filter (maintenance free up to one year*) is equipped as standard accessory.
* 8 hr/day, 25 day/month. For dust concentration of 0.15 mg/m³
- Major maintenance work can be performed by removing the panel. A flat-type suction grille and a detachable blade make cleaning easy.

Ceiling Mounted Cassette Corner Type

**FXKQ25MA/FXKQ32MA
FXKQ40MA/FXKQ63MA**



Slim design for flexible installation

- Slim body needs only 220 mm space above the ceiling. If you use a panel spacer (option), the unit can be installed in the minimum space of 195 mm.

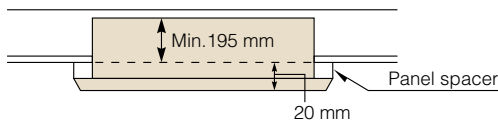

- Single-flow type allows effective air discharge from corner or from drop-ceiling.
- Drain pump is equipped as standard accessory with 500 mm lift.

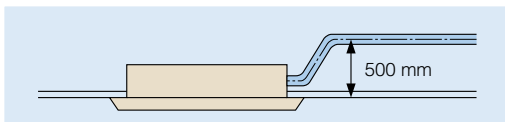

- Providing 3 different settings of standard, draft prevention and ceiling soiling prevention, the auto swing mechanism achieves even distribution of airflow and room temperature.

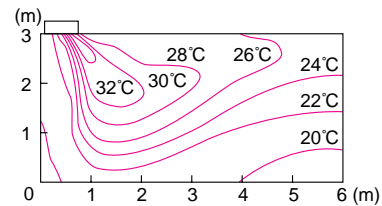

- Front discharge is possible with an air discharge unit (option), which allows the installation in the drop-ceiling or sagging wall.

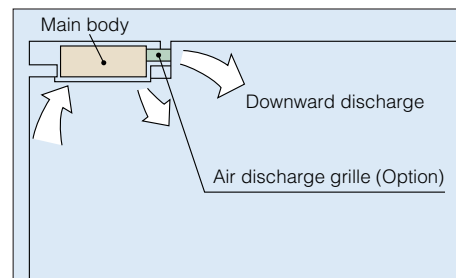

*Set for front discharge using a suspended ceiling.

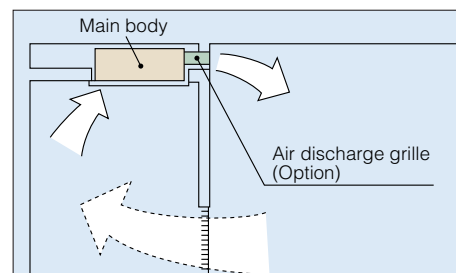

*Downward discharge is shut off and air is blown straight out (front discharge).

- A long-life filter (maintenance free up to one year*) is equipped as standard accessory.

* 8 hr/day, 25 day/month. For dust concentration of 0.15 mg/m³

Slim Ceiling Mounted Duct Type

Slim design, quietness and static pressure switching

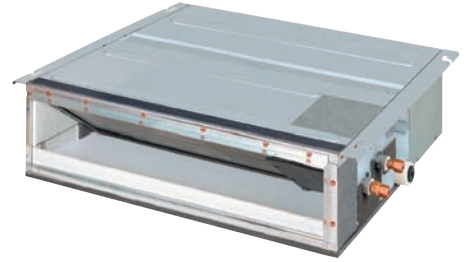

Suited for use in drop-ceilings!

FXDQ20PB/FXDQ25PB/FXDQ32PB

- Only 700 mm in width and 23 kg in weight, this model is suitable to install in limited spaces like drop-ceilings in hotels.

Great for hotel use!

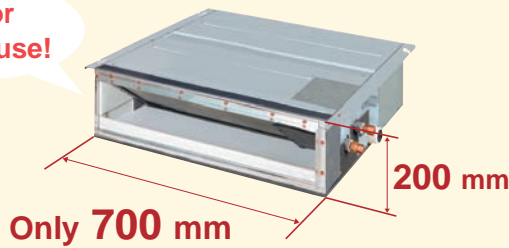

FXDQ40NB/FXDQ50NB/FXDQ63NB

- Only 200 mm in height, this model can be installed in rooms with as little as 240 mm depth between the drop-ceiling and ceiling slab.

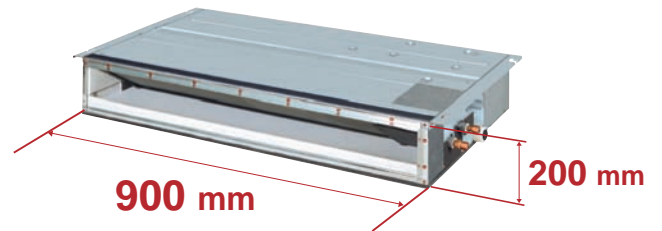

* 1,100 mm in width for the FXDQ63NB model.

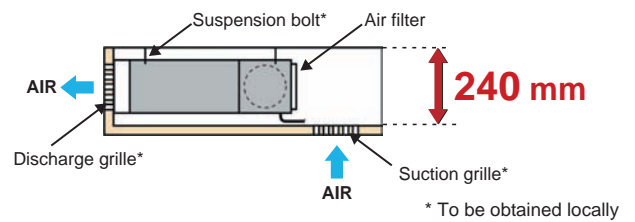

- External static pressure selectable by remote controller switching make this indoor unit a very comfortable and flexible model.

10 Pa-30 Pa/factory set: 10 Pa for FXDQ-PB models.
15 Pa-44 Pa/factory set: 15 Pa for FXDQ-NB models.

- Drain pump is equipped as standard accessory with 750 mm lift.

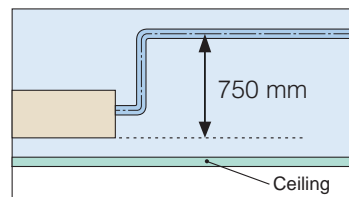

- Control of the airflow rate has been improved from 2-step to 3-step control.

- Low operation sound level

FXDQ-PB/NB	20/25/32	40	50	63
Sound level (HH/H/L)	33/31/29	34/32/30	35/33/31	36/34/32

(dB(A))

* The values of operation sound level represent those for rear-suction operation. Sound level values for bottom-suction operation can be obtained by adding 5 dB(A).
* Values are based on the following conditions:
FXDQ-PB: external static pressure of 10 Pa; FXDQ-NB: external static pressure of 15 Pa.

Ceiling Mounted Built-in Type

FXSYQ20M/FXSYQ25M/FXSYQ32M
 FXSYQ40M/FXSYQ50M/FXSYQ63M
 FXSYQ80M/FXSYQ100M/FXSYQ125M



Highly flexible for various application

- Highly flexible installation is possible with a complete lineup of optional kits to satisfy various needs, such as the design concept, interior decoration and so on.
- The unit can be installed, if there is a space of 350 mm above ceiling. (when suction panel is used.)

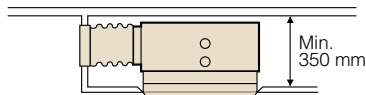

- Drain pump is equipped as standard accessory with 250 mm lift.

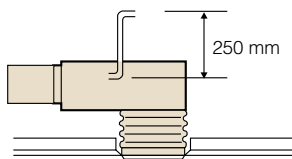

- High external static pressure allows the use of flexible ducts of various length.

- Low operation sound level (230 V)(dB(A))

FXSYQ-M	20/25/32	40	50	63	80/100	125
Sound level (H/L)	41/33.5	41/34.5	43/37	45/38.5	48/43	49/41.5

*The values of operation sound level are based on Australian Standard 1217.6-1985. Measurement is based on bottom-return air entry.

Installation examples (*Optional parts)

•Standard

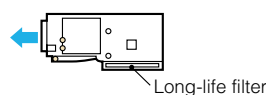

•Cassette style (standard filter)

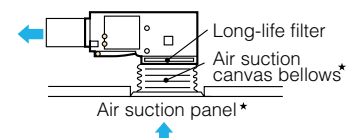

•Cassette style (high efficiency filter)

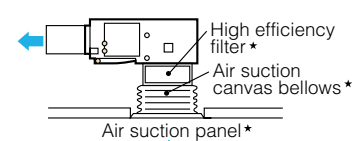

•With duct

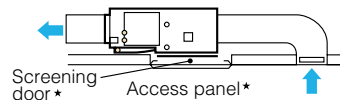

•Ceiling return

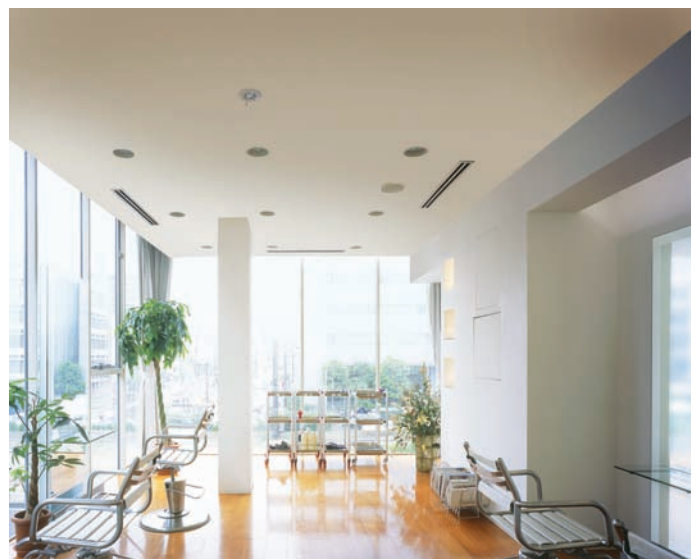
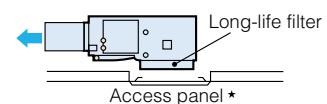

Ceiling Concealed (Duct) Type

FXDYQ80MA/FXDYQ100MA
FXDYQ125MA/FXDYQ145MA
FXDYQ180M/FXDYQ200M
FXDYQ250M



High static pressure offers flexible duct design that blends in with any interior décor in stores and offices

- High efficiency Hi-X heat exchanger coils that provide even more energy savings.
- High external static pressure allows comprehensive duct layout for various applications.
 - 120 Pa for FXDYQ80MA–145MA
 - 150 Pa for FXDYQ180M
 - 180 Pa for FXDYQ200M
 - 200 Pa for FXDYQ250M
- Design of indoor units allows installation in limited roof spaces.
- Return air spigots included for ease of installation for FXDYQ80MA-145MA models.
- Two external static pressure settings for added flexibility.
- Quiet yet powerful supply air fan.
- High strength galvanised steel casing.



Ceiling Mounted Duct Type

FXMQ20P/FXMQ25P/FXMQ32P
FXMQ40P/FXMQ50P/FXMQ63P
FXMQ80P/FXMQ100P/FXMQ125P
FXMQ140P



Middle and high static pressure allows for flexible duct design

- A DC fan motor increases the external static pressure capacity range to include middle to high static pressures, increasing design flexibility.

30 Pa–100 Pa for FXMQ20P-32P

30 Pa–160 Pa for FXMQ40P

50 Pa–200 Pa for FXMQ50P-125P

50 Pa–140 Pa for FXMQ140P

- All models are only 300 mm in height, an improvement over the 390 mm height of conventional models. The weight of the FXMQ40P has been reduced from 44 kg to 28 kg.

- Drain pump is equipped as standard accessory with 700 mm lift.

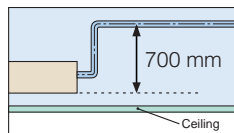

- Control of the airflow rate has been improved from 2-step to 3-step control.

- Low operation sound level (dB(A))

FXMQ-P	20/25	32	40	50	63	80/100	125	140
Sound level (HH/H/L)	33/31/29	34/32/30	39/37/35	41/39/37	42/40/38	43/41/39	44/42/40	46/45/43

- Energy-efficient

- The adopted DC fan motor is much more efficient than the conventional AC motor, yielding an approximate 20% decrease in energy consumption (FXMQ125P).

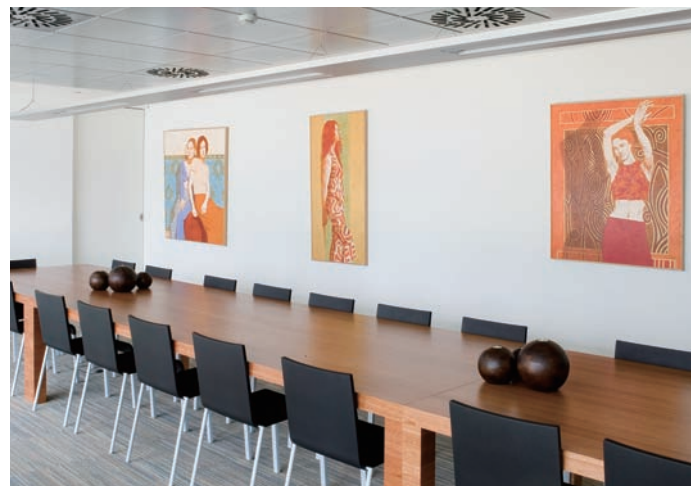

- Improved ease of installation

- Airflow rate can be controlled using a remote controller during test operation. With the conventional model, the airflow rate was controlled from the PC board. It is automatically adjusted to the range between approximately $\pm 10\%$ of the rated HH tap airflow for FXMQ20P-125P.

- Improved ease of maintenance

- The drain pan can be detached for easy cleaning. An antibacterial treatment that uses silver ions has been applied to the drain pan, preventing the growth of slime, mould and bacteria that cause blockages and odours.

FXMQ200MA/FXMQ250MA



- Simplified Static Pressure Control
External static pressure can be easily adjusted using a change-over switch inside the electrical box to meet the resistance in the duct system.

- Built-in Drain Pump (Option)

Housing the drain pump inside the unit reduces the space required for installation.

- Without drain pump

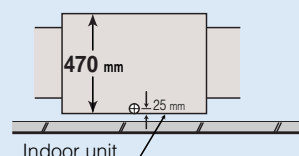

- With drain pump

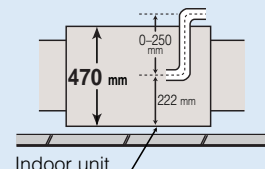

Ceiling Suspended Type

**FXHQ32MA/FXHQ63MA
FXHQ100MA**

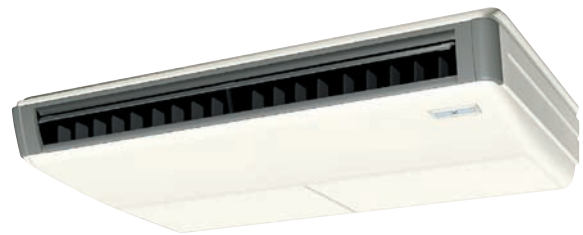

Slim body with quiet and wide airflow

●Adoption of QUIET STREAM FAN

Uses the quiet stream fan and many more advanced technologies.

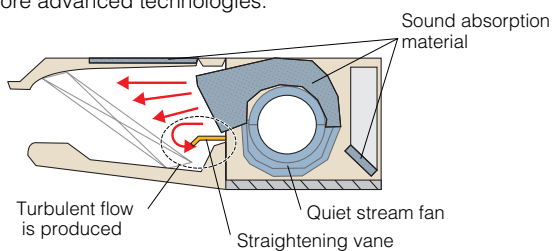

●Low operation sound level

(dB(A))

FXHQ-MA	32	63	100
Sound level (H/L)	36/31	39/34	45/37

●Installation is easy

- Drain pump kit (option) can be easily incorporated.

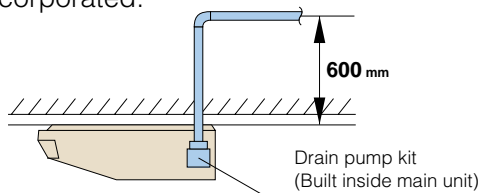

●Wide air discharge openings produce a spreading 100° airflow.

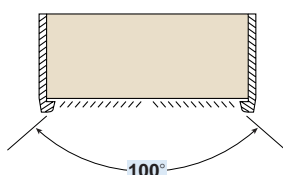

●Maintenance is easy

- Non-dew Flap with no implanted bristles

Bristle-free Flap minimises contamination and makes cleaning simpler.



Non-dew Flap

- Easy-to-clean flat design
- Maintenance is easier because servicing can be performed from below the unit.
- A long-life filter (maintenance free up to one year*) is equipped as standard accessory.

* 8 hr/day, 25 day/month. For dust concentration of 0.15 mg/m³

Wall Mounted Type

New

FXAQ20P/FXAQ25P
FXAQ32P/FXAQ40P
FXAQ50P/FXAQ63P



Stylish flat panel design harmonised with your interior décor

- Stylish flat panel design creates a graceful harmony that enhances any interior space.
- Flat panel can be cleaned with only the single pass of a cloth across their smooth surface. Flat panel can also be easily removed and washed for more thorough cleaning.

- Low operation sound level (dB(A))

FXAQ-P	20	25	32	40	50	63
Sound level (H/L)	35/31	36/31	38/31	39/34	42/37	47/41

- Drain pan and air filter can be kept clean by mould-proof polystyrene.
- Vertical auto-swing realises efficiency of air distribution. The louvre closes automatically when the unit stops.
- 5 steps of discharge angle can be set by remote controller.
- Discharge angle is automatically set at the same angle as the previous operation when restarting. (Initial setting: 10° for cooling and 70° for heating)

- Flexible installation

- Drain pipe can be fitted to from either left or right sides.



- Drain pump kit is available as optional accessory, which lifts the drain 1,000 mm from the bottom of the unit.

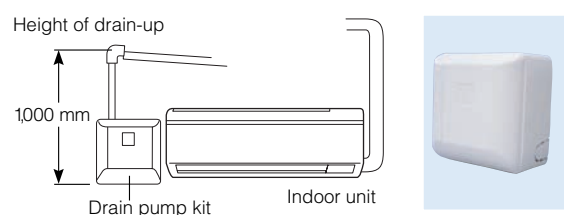

Floor Standing Type

FXLQ20MA/FXLQ25MA
FXLQ32MA/FXLQ40MA
FXLQ50MA/FXLQ63MA



Suitable for perimeter zone air conditioning

- Floor Standing types can be hung on the wall for easier floor cleaning. Running the piping from the back allows the unit to be hung on walls. Cleaning under the unit, where dust tends to accumulate, is considerably easier.
- The adoption of a fibre-less discharge grille featuring an original design to prevent condensation also helps prevent staining and makes cleaning easier.
- A long-life filter (maintenance free up to one year*) is equipped as standard accessory.

* 8 hr/day, 25 day/month. For dust concentration of 0.15 mg/m³

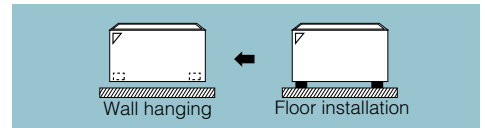

Concealed Floor Standing Type

FXNQ20MA/FXNQ25MA
FXNQ32MA/FXNQ40MA
FXNQ50MA/FXNQ63MA



Designed to be concealed in the perimeter skirting-wall

- The unit is concealed in skirting-wall of perimeter, that enables to create high class interior design.
- The connecting port faces downward, greatly facilitating on-site piping work.
- A long-life filter (maintenance free up to one year*) is equipped as standard accessory.

* 8 hr/day, 25 day/month. For dust concentration of 0.15 mg/m³

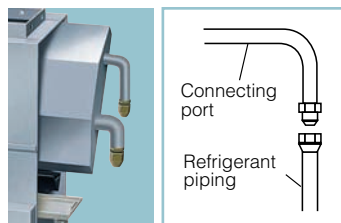

* Applies also to Floor Standing type (FXLQ-MA).



Connection unit series indoor units

Ceiling Suspended Cassette Type

FXUQ71MA/FXUQ100MA
FXUQ125MA



This thin indoor unit achieves optimum air distribution, and can be installed without the need for ceiling cavity.

- Depending on installation site requirements or room conditions, 2-way, 3-way and 4-way discharge patterns are available.

● 4-way airflow from the centre of the store.

● The 3-way airflow can distribute comfortable air throughout the room.

● Only one unit is needed to distribute comfortable air throughout an L-shaped store.



Connection unit

Connection unit is the device for connecting above indoor unit to VRVIII.

BEVQ71MA/BEVQ100MA/BEVQ125MA

Refrigerant piping layout

External wiring layout

Model	Maximum piping length between the BEV unit and the indoor unit.
FXUQ-MA	5 m

Notes:

- When connecting centralised-control device, it is necessary to install an interface adaptor for an indoor unit (DTA102A52).
- Connection unit BEVQ-MA is necessary for each indoor unit.
- The refrigerant piping height difference between the indoor units and the BEV unit must be within 4 m.
- The BEV unit must be installed within a maximum height difference between indoor units of 15 m.
- Branching of the refrigerant piping is not possible downstream of the BEV unit.

Cooling Only/Heat Pump

Standard Model (Space Saving Type)

- Between 12 (5 class (14 kW)) and up to 64 (54 class (147 kW)) indoor units in a single refrigerant piping circuit can be individually controlled in minimum increments of 2.2 kW. Facilities from small to large can be accommodated with the lineup of 5–54 class (14–147 kW) models. The units are superbly compact, so less installation space is required.
- Outdoor units with anti-corrosion specifications (-E type on request) are designed specifically for use in areas which are subject to salt damage and atmospheric pollution. These products are available for the heat pump type only.

5 class



RX(Y)Q5PA(E)

New **6*, 8, 10 class**



New RX(Y)Q6PA
RX(Y)Q8PA(E)
RX(Y)Q10PA(E)

* 6 class model is available for the heat pump type only.

12, 14, 16, 18 class



RX(Y)Q12PA(E)
RX(Y)Q14PA(E)
RX(Y)Q16PA(E)
RX(Y)Q18PA(E)

20, 22, 24, 26, 28 class



RX(Y)Q20PA(E)
RX(Y)Q22PA(E)
RX(Y)Q24PA(E)
RX(Y)Q26PA(E)
RX(Y)Q28PA(E)

30, 32, 34, 36 class



RX(Y)Q30PA(E)
RX(Y)Q32PA(E)
RX(Y)Q34PA(E)
RX(Y)Q36PA(E)

38, 40, 42, 44, 46 class



RX(Y)Q38PA(E)
RX(Y)Q40PA(E)
RX(Y)Q42PA(E)
RX(Y)Q44PA(E)
RX(Y)Q46PA(E)

48, 50, 52, 54 class



RX(Y)Q48PA(E)
RX(Y)Q50PA(E)
RX(Y)Q52PA(E)
RX(Y)Q54PA(E)

High Efficiency Model (Energy Saving Type)

- High efficiency model outdoor units offer highly efficient performance, contributing to energy savings, while a lineup of 16–50 class (44.8–139 kW) models extends the range of applications.
- Outdoor units with anti-corrosion specifications (-E type on request) are designed specifically for use in areas which are subject to salt damage and atmospheric pollution. These products are available for the heat pump type only.

16, 18 class



RX(Y)Q16PAH(E)
RX(Y)Q18PAH(E)

24, 26 class



RX(Y)Q24PAH(E)
RX(Y)Q26PAH(E)

28, 30 class



RX(Y)Q28PAH(E)
RX(Y)Q30PAH(E)

32, 34 class



RX(Y)Q32PAH(E)
RX(Y)Q34PAH(E)

36, 38, 40, 42, 44, 46, 48, 50 class



RX(Y)Q36PAH(E) RX(Y)Q44PAH(E)
RX(Y)Q38PAH(E) RX(Y)Q46PAH(E)
RX(Y)Q40PAH(E) RX(Y)Q48PAH(E)
RX(Y)Q42PAH(E) RX(Y)Q50PAH(E)

Series Lineup

Series		Class																									
		5	6*	8	10	12	14	16	18	20	22	24	26	28	30	32	34	36	38	40	42	44	46	48	50	52	54
Cooling Only/ Heat Pump	Standard Model	●	● ^{New}	●	●	●	●	●	●	●	●	●	●	●	●	●	●	●	●	●	●	●	●	●	●	●	●
	High Efficiency Model	—	—	—	—	—	—	●	●	—	—	●	●	●	●	●	●	●	●	●	●	●	●	●	—	—	

* 6 class model is available for the heat pump type only.

Outdoor Unit Combinations

Standard Model (Space Saving Type)

Class	kW	Capacity index	Model name	Combination	Outdoor unit multi connection piping kit*1	Total capacity index of connectable indoor units*2	Maximum number of connectable indoor units*2
5	14.0	125	RX(Y)Q5PA	RX(Y)Q5PA	–	62.5 to 162.5 (250)	8 (12)
6	16.0	150	RXYQ6PA	RXYQ6PA	–	105 to 195 (300)	10 (15)
8	22.4	200	RX(Y)Q8PA	RX(Y)Q8PA	–	100 to 260 (400)	13 (20)
10	28.0	250	RX(Y)Q10PA	RX(Y)Q10PA	–	125 to 325 (500)	16 (25)
12	33.5	300	RX(Y)Q12PA	RX(Y)Q12PA	–	150 to 390 (600)	19 (30)
14	40.0	350	RX(Y)Q14PA	RX(Y)Q14PA	–	175 to 455 (700)	23 (35)
16	45.0	400	RX(Y)Q16PA	RX(Y)Q16PA	–	200 to 520 (800)	26 (40)
18	49.0	450	RX(Y)Q18PA	RX(Y)Q18PA	–	225 to 585 (900)	29 (45)
20	55.9	500	RX(Y)Q20PA	RX(Y)Q8PA + RX(Y)Q12PA	BHFP22P100	250 to 650 (800)	32 (40)
22	61.5	550	RX(Y)Q22PA	RX(Y)Q10PA + RX(Y)Q12PA		275 to 715 (880)	35 (44)
24	67.4	600	RX(Y)Q24PA	RX(Y)Q8PA + RX(Y)Q16PA		300 to 780 (960)	39 (48)
26	71.4	650	RX(Y)Q26PA	RX(Y)Q8PA + RX(Y)Q18PA		325 to 845 (1,040)	42 (52)
28	77.0	700	RX(Y)Q28PA	RX(Y)Q10PA + RX(Y)Q18PA		350 to 910 (1,120)	45 (56)
30	82.5	750	RX(Y)Q30PA	RX(Y)Q12PA + RX(Y)Q18PA		375 to 975 (1,200)	48 (60)
32	90.0	800	RX(Y)Q32PA	RX(Y)Q16PA x 2		400 to 1,040 (1,280)	52 (64)
34	94.0	850	RX(Y)Q34PA	RX(Y)Q16PA + RX(Y)Q18PA		425 to 1,105 (1,360)	55 (64)
36	98.0	900	RX(Y)Q36PA	RX(Y)Q18PA x 2		450 to 1,170 (1,440)	58 (64)
38	105	950	RX(Y)Q38PA	RX(Y)Q8PA + RX(Y)Q12PA + RX(Y)Q18PA		475 to 1,235 (1,235)	61 (61)
40	112	1,000	RX(Y)Q40PA	RX(Y)Q8PA + RX(Y)Q16PA x 2	BHFP22P151	500 to 1,300 (1,300)	64 (64)
42	116	1,050	RX(Y)Q42PA	RX(Y)Q8PA + RX(Y)Q16PA + RX(Y)Q18PA		525 to 1,365 (1,365)	
44	120	1,100	RX(Y)Q44PA	RX(Y)Q8PA + RX(Y)Q18PA x 2		550 to 1,430 (1,430)	
46	126	1,150	RX(Y)Q46PA	RX(Y)Q10PA + RX(Y)Q18PA x 2		575 to 1,495 (1,495)	
48	132	1,200	RX(Y)Q48PA	RX(Y)Q12PA + RX(Y)Q18PA x 2		600 to 1,560 (1,560)	
50	138	1,250	RX(Y)Q50PA	RX(Y)Q14PA + RX(Y)Q18PA x 2		625 to 1,625 (1,625)	
52	143	1,300	RX(Y)Q52PA	RX(Y)Q16PA + RX(Y)Q18PA x 2		650 to 1,690 (1,690)	
54	147	1,350	RX(Y)Q54PA	RX(Y)Q18PA x 3		675 to 1,755 (1,755)	

*1 For multiple connection of 20 class (55.9 kW) systems and above, the outdoor unit multi connection piping kit (separately sold) is required.

*2 Values inside brackets are based on connection of indoor units rated at maximum capacity, 200% for single outdoor units, 160% for double outdoor units, and 130% for triple outdoor units. Refer to page 9 for notes on connection capacity of indoor units.

High Efficiency Type (Energy Saving Type)

Class	kW	Capacity index	Model name	Combination	Outdoor unit multi connection piping kit*1	Total capacity index of connectable indoor units*2	Maximum number of connectable indoor units*2
16	44.8	400	RX(Y)Q16PAH	RX(Y)Q8PA x 2	BHFP22P100	200 to 520 (640)	26 (32)
18	50.4	450	RX(Y)Q18PAH	RX(Y)Q8PA + RX(Y)Q10PA		225 to 585 (720)	29 (36)
24	67.2	600	RX(Y)Q24PAH	RX(Y)Q8PA x 3	BHFP22P151	300 to 780 (780)	39 (39)
26	72.8	650	RX(Y)Q26PAH	RX(Y)Q8PA x 2 + RX(Y)Q10PA		325 to 845 (845)	42 (42)
28	78.3	700	RX(Y)Q28PAH	RX(Y)Q8PA x 2 + RX(Y)Q12PA		350 to 910 (910)	45 (45)
30	83.9	750	RX(Y)Q30PAH	RX(Y)Q8PA + RX(Y)Q10PA + RX(Y)Q12PA		375 to 975 (975)	48 (48)
32	89.4	800	RX(Y)Q32PAH	RX(Y)Q8PA + RX(Y)Q12PA x 2		400 to 1,040 (1,040)	52 (52)
34	95.0	850	RX(Y)Q34PAH	RX(Y)Q10PA + RX(Y)Q12PA x 2		425 to 1,105 (1,105)	55 (55)
36	101	900	RX(Y)Q36PAH	RX(Y)Q12PA x 3		450 to 1,170 (1,170)	58 (58)
38	107	950	RX(Y)Q38PAH	RX(Y)Q12PA x 2 + RX(Y)Q14PA		475 to 1,235 (1,235)	61 (61)
40	112	1,000	RX(Y)Q40PAH	RX(Y)Q12PA x 2 + RX(Y)Q16PA		500 to 1,300 (1,300)	64 (64)
42	116	1,050	RX(Y)Q42PAH	RX(Y)Q12PA x 2 + RX(Y)Q18PA		525 to 1,365 (1,365)	
44	124	1,100	RX(Y)Q44PAH	RX(Y)Q12PA + RX(Y)Q16PA x 2	550 to 1,430 (1,430)		
46	128	1,150	RX(Y)Q46PAH	RX(Y)Q12PA + RX(Y)Q16PA + RX(Y)Q18PA	575 to 1,495 (1,495)		
48	135	1,200	RX(Y)Q48PAH	RX(Y)Q16PA x 3	600 to 1,560 (1,560)		
50	139	1,250	RX(Y)Q50PAH	RX(Y)Q16PA x 2 + RX(Y)Q18PA	625 to 1,625 (1,625)		

*1 For multiple connection of 16 class (44.8 kW) systems and above, the outdoor unit multi connection piping kit (separately sold) is required.

*2 Values inside brackets are based on connection of indoor units rated at maximum capacity, 200% for single outdoor units, 160% for double outdoor units, and 130% for triple outdoor units. Refer to page 9 for notes on connection capacity of indoor units.

Specifications—Indoor Units

Ceiling Mounted Cassette (Round Flow) Type



MODEL		FXFQ25PVE	FXFQ32PVE	FXFQ40PVE	FXFQ50PVE	FXFQ63PVE	FXFQ80PVE	FXFQ100PVE	FXFQ125PVE	
Power supply		1-phase, 220-240 V/220 V, 50/60 Hz								
Cooling capacity	kcal/h (*1)	2,500	3,200	4,000	5,000	6,300	8,000	10,000	12,500	
	Btu/h (*1)	9,900	12,600	16,000	19,800	24,900	31,700	39,600	49,500	
	kW	(*1)	2.9	3.7	4.7	5.8	7.3	9.3	11.6	14.5
		(*2)	2.8	3.6	4.5	5.6	7.1	9.0	11.2	14.0
Heating capacity	kcal/h	2,800	3,400	4,300	5,400	6,900	8,600	10,800	13,800	
	Btu/h	10,900	13,600	17,100	21,500	27,300	34,100	42,700	54,600	
	kW	3.2	4.0	5.0	6.3	8.0	10.0	12.5	16.0	
Power consumption	Cooling	kW	0.033	0.033	0.047	0.052	0.066	0.093	0.187	0.209
	Heating		0.027	0.027	0.034	0.038	0.053	0.075	0.174	0.200
Casing		Galvanised steel plate								
Airflow rate (HH/H/L)	ℓ/s	216/191/166	216/191/166	250/216/183	266/225/183	316/275/225	350/300/250	533/433/333	550/466/375	
	m ³ /min	13/11.5/10	13/11.5/10	15/13/11	16/13.5/11	19/16.5/13.5	21/18/15	32/26/20	33/28/22.5	
Sound level (HH/H/L)	dB(A)	30/28.5/27	30/28.5/27	31/29/27	32/29.5/27	34/31/28	36/33.5/31	43/37.5/32	44/39/34	
Sound power (HH/H/L)	dB(A)	48/46.5/45	48/46.5/45	49/47/45	50/47.5/45	52/49/46	53/51.5/49	60/54.5/50	61/56/52	
Dimensions (H×W×D)	mm	246×840×840	246×840×840	246×840×840	246×840×840	246×840×840	246×840×840	288×840×840	288×840×840	
Machine weight	kg	19.5	19.5	19.5	19.5	22	22	25	25	
Piping connections	Liquid (Flare)	mm	φ 6.4	φ 6.4	φ 6.4	φ 6.4	φ 9.5	φ 9.5	φ 9.5	
	Gas (Flare)		φ 12.7	φ 12.7	φ 12.7	φ 12.7	φ 15.9	φ 15.9	φ 15.9	
	Drain		VP25 (External Dia, 32/Internal Dia, 25)							
Panel (Option)	Model	BYCP125K-W1								
	Colour	Fresh white								
	Dimensions (H×W×D)	mm	50×950×950	50×950×950	50×950×950	50×950×950	50×950×950	50×950×950	50×950×950	
	Weight	kg	5.5	5.5	5.5	5.5	5.5	5.5	5.5	

Ceiling Mounted Cassette (Compact Multi Flow) Type



MODEL		FXZQ20MVE	FXZQ25MVE	FXZQ32MVE	FXZQ40MVE	FXZQ50MVE	
Power supply		1-phase, 220-240 V/220 V, 50 Hz/60 Hz					
Cooling capacity	kcal/h (*1)	2,000	2,500	3,200	4,000	5,000	
	Btu/h (*1)	7,800	9,900	12,600	16,000	19,800	
	kW	(*1)	2.3	2.9	3.7	4.7	5.8
		(*2)	2.2	2.8	3.6	4.5	5.6
Heating capacity	kcal/h	2,200	2,800	3,400	4,300	5,400	
	Btu/h	8,500	10,900	13,600	17,100	21,500	
	kW	2.5	3.2	4.0	5.0	6.3	
Power consumption	Cooling	kW	0.073	0.073	0.076	0.089	0.115
	Heating		0.064	0.064	0.068	0.080	0.107
Casing		Galvanised steel plate					
Airflow rate (H/L)	ℓ/s	150/116	150/116	158/125	183/133	233/166	
	m ³ /min	9/7	9/7	9.5/7.5	11/8	14/10	
Sound level (H/L)	240 V dB(A)	32/26	32/26	34/28	37/29	42/35	
Sound power (H)	240 V dB(A)	49	49	51	54	59	
Dimensions (H×W×D)	mm	286×575×575					
Machine weight	kg	18					
Piping connections	Liquid (Flare)	mm	φ 6.4	φ 6.4	φ 6.4	φ 6.4	
	Gas (Flare)		φ 12.7	φ 12.7	φ 12.7	φ 12.7	
	Drain		VP20 (External Dia, 26/Internal Dia, 20)				
Panel (Option)	Model	BYFQ60B8W1					
	Colour	White (6.5Y9.5/0.5)					
	Dimensions (H×W×D)	mm	55×700×700	55×700×700	55×700×700	55×700×700	
	Weight	kg	2.7	2.7	2.7	2.7	

Note: Specifications are based on the following conditions;

- Cooling: (*1) Indoor temp.: 27°CDB, 19.5°CWB, Outdoor temp.: 35°CDB, Equivalent piping length: 7.5 m, Level difference: 0 m.
(*2) Indoor temp.: 27°CDB, 19°CWB, Outdoor temp.: 35°CDB, Equivalent piping length: 7.5 m, Level difference: 0 m.
- Heating: Indoor temp.: 20°CDB, Outdoor temp.: 7°CDB, 6°CWB, Equivalent piping length: 7.5 m, Level difference: 0 m.
- Capacity of indoor unit is only for reference. Actual capacity of indoor unit is based on the total capacity index.
(See Engineering Data Book for details.)
- Sound level: Anechoic chamber conversion value, measured at a point 1.5 m downward from the unit centre.
During actual operation, these values are normally somewhat higher as a result of ambient conditions.

Ceiling Mounted Cassette (Double Flow) Type



MODEL		FXCQ20MVE	FXCQ25MVE	FXCQ32MVE	FXCQ40MVE	FXCQ50MVE	FXCQ63MVE	FXCQ80MVE	FXCQ125MVE	
Power supply		1-phase, 220-240 V/220 V, 50/60 Hz								
Cooling capacity	kcal/h(*1)	2,000	2,500	3,200	4,000	5,000	6,300	8,000	12,500	
	Btu/h(*1)	7,800	9,900	12,600	16,000	19,800	24,900	31,700	49,500	
	kW	(*1)	2.3	2.9	3.7	4.7	5.8	7.3	9.3	14.5
(*2)		2.2	2.8	3.6	4.5	5.6	7.1	9.0	14.0	
Heating capacity	kcal/h	2,200	2,800	3,400	4,300	5,400	6,900	8,600	13,800	
	Btu/h	8,500	10,900	13,600	17,100	21,500	27,300	34,100	54,600	
	kW	2.5	3.2	4.0	5.0	6.3	8.0	10.0	16.0	
Power consumption	Cooling	kW	0.077	0.092	0.092	0.130	0.130	0.161	0.209	0.256
	Heating		0.044	0.059	0.059	0.097	0.097	0.126	0.176	0.223
Casing		Galvanised steel plate								
Airflow rate (H/L)	ℓ/s	116/83	150/108	150/108	200/150	200/150	275/216	433/350	550/416	
	m ³ /min	7/5	9/6.5	9/6.5	12/9	12/9	16.5/13	26/21	33/25	
Sound level (H/L)	240 V	dB(A)	34/29	36/30	36/30	37/32	37/32	39/34	41/36	46/40
Dimensions (H×W×D)		mm	305×775×600	305×775×600	305×775×600	305×990×600	305×990×600	305×1,175×600	305×1,665×600	305×1,665×600
Machine weight		kg	26	26	26	31	32	35	47	48
Piping connections	Liquid (Flare)	mm	φ 6.4	φ 6.4	φ 6.4	φ 6.4	φ 6.4	φ 9.5	φ 9.5	φ 9.5
	Gas (Flare)		φ 12.7	φ 12.7	φ 12.7	φ 12.7	φ 12.7	φ 15.9	φ 15.9	φ 15.9
	Drain		VP25 (External Dia, 32/Internal Dia, 25)							
Panel (Option)	Model	BYBC32G-W1		BYBC50G-W1		BYBC63G-W1		BYBC125G-W1		
	Colour	White (10Y9/0.5)								
	Dimensions(H×W×D)	mm	53×1,030×680	53×1,030×680	53×1,030×680	53×1,245×680	53×1,245×680	53×1,430×680	53×1,920×680	53×1,920×680
	Weight	kg	8.0	8.0	8.0	8.5	8.5	9.5	12.0	12.0

Ceiling Mounted Cassette Corner Type



MODEL		FXKQ25MAVE	FXKQ32MAVE	FXKQ40MAVE	FXKQ63MAVE	
Power supply		1-phase, 220-240 V/220 V, 50/60 Hz				
Cooling capacity	kcal/h(*1)	2,500	3,200	4,000	6,300	
	Btu/h(*1)	9,900	12,600	16,000	24,900	
	kW	(*1)	2.9	3.7	4.7	7.3
(*2)		2.8	3.6	4.5	7.1	
Heating capacity	kcal/h	2,800	3,400	4,300	6,900	
	Btu/h	10,900	13,600	17,100	27,300	
	kW	3.2	4.0	5.0	8.0	
Power consumption	Cooling	kW	0.066	0.066	0.076	0.105
	Heating		0.046	0.046	0.056	0.085
Casing		Galvanised steel plate				
Airflow rate (H/L)	ℓ/s	183/150	183/150	216/166	300/250	
	m ³ /min	11/9	11/9	13/10	18/15	
Sound level (H/L)	240 V	dB(A)	40/35	40/35	42/36	44/39
Dimensions (H×W×D)		mm	215×1,110×710	215×1,110×710	215×1,110×710	215×1,310×710
Machine weight		kg	31	31	31	34
Piping connections	Liquid (Flare)	mm	φ 6.4	φ 6.4	φ 6.4	φ 9.5
	Gas (Flare)		φ 12.7	φ 12.7	φ 12.7	φ 15.9
	Drain		VP25 (External Dia, 32/Internal Dia, 25)			
Panel (Option)	Model	BYK45FJW1		BYK71FJW1		
	Colour	White (10Y9/0.5)				
	Dimensions(H×W×D)	mm	70×1,240×800	70×1,240×800	70×1,240×800	70×1,440×800
	Weight	kg	8.5	8.5	8.5	9.5

Note: Specifications are based on the following conditions:

- Cooling: (*1) Indoor temp.: 27°CDB, 19.5°CWB, Outdoor temp.: 35°CDB, Equivalent piping length: 7.5 m, Level difference: 0 m.
(*2) Indoor temp.: 27°CDB, 19°CWB, Outdoor temp.: 35°CDB, Equivalent piping length: 7.5 m, Level difference: 0 m.
- Heating: Indoor temp.: 20°CDB, Outdoor temp.: 7°CDB, 6°CWB, Equivalent piping length: 7.5 m, Level difference: 0 m.
- Capacity of indoor unit is only for reference. Actual capacity of indoor unit is based on the total capacity index. (See Engineering Data Book for details.)
- Sound level: (FXCQ-M) Anechoic chamber conversion value, measured at a point 1.5 m downward from the unit centre.
(FXKQ-MA) Anechoic chamber conversion value, measured at a point 1 m in front of the unit and 1 m downward.
During actual operation, these values are normally somewhat higher as a result of ambient conditions.

Specifications—Indoor Units

Slim Ceiling Mounted Duct Type (700 mm width type)

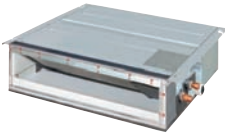

MODEL		FXDQ20PBVE	FXDQ25PBVE	FXDQ32PBVE	
Power supply		1-phase, 220-240 V/220 V, 50/60 Hz			
Cooling capacity	kcal/h (*1)	2,000	2,500	3,200	
	Btu/h (*1)	7,800	9,900	12,600	
	kW	(*1)	2.3	2.9	3.7
		(*2)	2.2	2.8	3.6
Heating capacity	kcal/h	2,200	2,800	3,400	
	Btu/h	8,500	10,900	13,600	
	kW	2.5	3.2	4.0	
Power consumption	Cooling	0.086	0.086	0.089	
	Heating	0.067	0.067	0.070	
Casing		Galvanised steel plate			
Airflow rate (HH/H/L)	ℓ/s	133/120/106	133/120/106	133/120/106	
	m ³ /min	8.0/7.2/6.4	8.0/7.2/6.4	8.0/7.2/6.4	
External static pressure	Pa	30-10*1			
Sound level (HH/H/L)*2*3	dB(A)	33/31/29	33/31/29	33/31/29	
Sound power (HH)	dB(A)	51	51	51	
Dimensions (H×W×D)	mm	200×700×620	200×700×620	200×700×620	
Machine weight	kg	23	23	23	
Piping connections	Liquid (Flare)	φ 6.4	φ 6.4	φ 6.4	
	Gas (Flare)	φ 12.7	φ 12.7	φ 12.7	
	Drain	VP20 (External Dia, 26/Internal Dia, 20)			

Slim Ceiling Mounted Duct Type (900/1,100 mm width type)

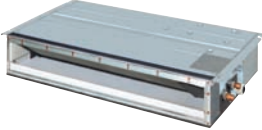

MODEL		FXDQ40NBVE	FXDQ50NBVE	FXDQ63NBVE	
Power supply		1-phase, 220-240 V/220 V, 50/60 Hz			
Cooling capacity	kcal/h (*1)	4,000	5,000	6,300	
	Btu/h (*1)	16,000	19,800	24,900	
	kW	(*1)	4.7	5.8	7.3
		(*2)	4.5	5.6	7.1
Heating capacity	kcal/h	4,300	5,400	6,900	
	Btu/h	17,100	21,500	27,300	
	kW	5.0	6.3	8.0	
Power consumption	Cooling	0.160	0.165	0.181	
	Heating	0.147	0.152	0.168	
Casing		Galvanised steel plate			
Airflow rate (HH/H/L)	ℓ/s	175/158/141	208/183/166	275/241/216	
	m ³ /min	10.5/9.5/8.5	12.5/11.0/10.0	16.5/14.5/13.0	
External static pressure	Pa	44-15*1			
Sound level (HH/H/L)*2*3	dB(A)	34/32/30	35/33/31	36/34/32	
Sound power (HH)	dB(A)	52	53	54	
Dimensions (H×W×D)	mm	200×900×620	200×900×620	200×1,100×620	
Machine weight	kg	27	28	31	
Piping connections	Liquid (Flare)	φ 6.4	φ 6.4	φ 9.5	
	Gas (Flare)	φ 12.7	φ 12.7	φ 15.9	
	Drain	VP20 (External Dia, 26/Internal Dia, 20)			

Note: Specifications are based on the following conditions;

•Cooling: (*1) Indoor temp.: 27°CDB, 19.5°CWB, Outdoor temp.: 35°CDB, Equivalent piping length: 7.5 m, Level difference: 0 m.
 (*2) Indoor temp.: 27°CDB, 19°CWB, Outdoor temp.: 35°CDB, Equivalent piping length: 7.5 m, Level difference: 0 m.

•Heating: Indoor temp.: 20°CDB, Outdoor temp.: 7°CDB, 6°CWB, Equivalent piping length: 7.5 m, Level difference: 0 m.

•Capacity of indoor unit is only for reference. Actual capacity of indoor unit is based on the total capacity index.

(See Engineering Data Book for details.)

•Sound level: Anechoic chamber conversion value, measured at a point 1.5 m downward from the unit centre.

During actual operation, these values are normally somewhat higher as a result of ambient conditions.

*1: External static pressure is changeable to set by the remote controller. This pressure means "High static pressure - Standard". (Factory setting is 10 Pa for FXDQ-PB models and 15 Pa for FXDQ-NB models.)

*2: The values of operation sound level represent those for rear-suction operation. Sound level values for bottom-suction operation can be obtained by adding 5 dB(A).

*3: Values are based on the following conditions: FXDQ-PB: external static pressure of 10 Pa; FXDQ-NB: external static pressure of 15 Pa.

Ceiling Mounted Built-in Type



MODEL		FXSYQ20MVE	FXSYQ25MVE	FXSYQ32MVE	FXSYQ40MVE	FXSYQ50MVE	FXSYQ63MVE	FXSYQ80MVE	FXSYQ100MVE	FXSYQ125MVE		
Power supply		1-phase, 220-240 V, 50 Hz										
Cooling capacity	kcal/h(*1)	2,000	2,500	3,200	4,000	5,000	6,300	8,000	10,000	12,500		
	Btu/h(*1)	7,900	9,900	12,600	16,000	19,800	24,900	31,700	39,600	49,500		
	kW	(*1)	2.3	2.9	3.7	4.7	5.8	7.3	9.3	11.6	14.5	
(*2)		2.2	2.8	3.6	4.5	5.6	7.1	9.0	11.2	14.0		
Heating capacity	kcal/h	2,200	2,800	3,400	4,300	5,400	6,900	8,600	10,800	13,800		
	Btu/h	8,500	10,900	13,600	17,100	21,500	27,300	34,100	42,700	54,600		
	kW	2.5	3.2	4.0	5.0	6.3	8.0	10.0	12.5	16.0		
Power consumption	Cooling	kW	0.089	0.089	0.096	0.106	0.145	0.178	0.304	0.309	0.366	
	Heating		0.089	0.089	0.096	0.106	0.145	0.178	0.304	0.309	0.366	
Casing		Galvanised steel plate										
Airflow rate (H/L)	ℓ/s	150/112	150/112	158/112	191/143	250/190	350/235	450/355	466/370	633/457		
	m ³ /min	9/6.72	9/6.72	9.5/6.72	11.5/8.58	15/11.4	21/14.1	27/21.3	28/22.2	38/27.42		
External static pressure	Pa	98-65-33*1	98-65-33*1	88-57-27*1	96-65-57*1	86-58-43*1	115-84-52*1	140-122-61*1	138-118-53*1	98-58*2		
Sound level (H/L)	230 V	dB(A)		41/33.5	41/33.5	41/33.5	41/34.5	43/37	45/38.5	48/43	48/43	49/41.5
Sound power (H/L)	230 V	dB(A)		58/50.5	58/50.5	58/50.5	58/51.5	60/54	62/55.5	65.5/60	65.5/60	66/59
Dimensions (H×W×D)	mm	300×550×800	300×550×800	300×550×800	300×700×800	300×700×800	300×1,000×800	300×1,400×800	300×1,400×800	300×1,400×800		
Machine weight	kg	30	30	30	34	35	44	57	57	57		
Piping connections	Liquid (Flare)	mm	φ 6.4	φ 6.4	φ 6.4	φ 6.4	φ 6.4	φ 9.5	φ 9.5	φ 9.5	φ 9.5	
	Gas (Flare)		φ 12.7	φ 12.7	φ 12.7	φ 12.7	φ 12.7	φ 15.9	φ 15.9	φ 15.9	φ 15.9	
	Drain		VP25 (External Dia, 32/Internal Dia, 25)									
Panel (Option)	Model	BYBS32DJW1	BYBS32DJW1	BYBS32DJW1	BYBS45DJW1	BYBS45DJW1	BYBS71DJW1	BYBS125DJW1	BYBS125DJW1	BYBS125DJW1		
	Colour	White (10Y9/0.5)										
	Dimensions (H×W×D)	mm	55×650×500	55×650×500	55×650×500	55×800×500	55×800×500	55×1,100×500	55×1,500×500	55×1,500×500	55×1,500×500	
	Weight	kg	3.0	3.0	3.0	3.5	3.5	4.5	6.5	6.5	6.5	

Ceiling Concealed (Duct) Type

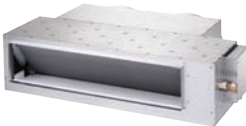

MODEL		FXDYQ80MAV1	FXDYQ100MAV1	FXDYQ125MAV1	FXDYQ145MAV1	FXDYQ180MAV1	FXDYQ200MAV1	FXDYQ250MAV1	
Power supply		1-phase, 220-240 V, 50 Hz							
Cooling capacity	kcal/h(*1)	8,000	10,000	12,500	14,500	17,700	19,800	24,800	
	Btu/h(*1)	31,700	39,600	49,500	57,600	70,300	78,500	98,300	
	kW	(*1)	9.3	11.6	14.5	16.9	20.6	23.0	28.8
(*2)		8.8	11.2	13.9	16.0	20.0	22.4	28.0	
Heating capacity	kcal/h	8,480	10,800	13,800	15,800	19,300	21,500	27,000	
	Btu/h	33,800	42,700	54,600	62,800	76,400	85,300	107,500	
	kW	9.9	12.5	16.0	18.4	22.4	25.0	31.5	
Power consumption	Cooling	kW	0.415	0.700	0.780	0.880	0.980	1.020	1.200
	Heating		0.415	0.700	0.780	0.880	0.980	1.020	1.200
Casing		Galvanised steel plate							
Airflow rate (H)	ℓ/s	510	778	852	957	1,180	1,200	1,400	
	m ³ /min	30.6	46.7	51.1	57.4	70.8	72.0	84.0	
External static pressure (H)	Pa	120*3	120*3	120*3	120*3	150	180	200	
Sound level (H)	240 V	dB(A)		45	46	48	51	51	51
Dimensions (H×W×D)	mm	360×1168×869	360×1478×899	360×1478×899	360×1478×899	500×1210×910	500×1210×910	500×1410×910	
Machine weight	kg	50	60	65	66	77	79	98	
Piping connections	Liquid (Flare)	mm	φ 9.5	φ 9.5	φ 9.5	φ 9.5	φ 9.5	φ 9.5	
	Gas (Flare)		φ 15.9	φ 15.9	φ 15.9	φ 15.9	φ 19.1	φ 19.1	
	Drain		VP25 (External Dia, 32/Internal Dia, 25)			BSP 3/4 inch internal thread			

Note: Specifications are based on the following conditions;

- Cooling: (*1) Indoor temp.: 27°CDB, 19.5°CWB, Outdoor temp.: 35°CDB, Equivalent piping length: 7.5 m, Level difference: 0 m.
(*2) Indoor temp.: 27°CDB, 19°CWB, Outdoor temp.: 35°CDB, Equivalent piping length: 7.5 m, Level difference: 0 m.
- Heating: Indoor temp.: 20°CDB, Outdoor temp.: 7°CDB, 6°CWB, Equivalent piping length: 7.5 m, Level difference: 0 m.
- Capacity of indoor unit is only for reference. Actual capacity of indoor unit is based on the total capacity index. (See Engineering Data Book for details.)
- Sound level: (FXSYQ) Anechoic chamber conversion value, based on Australian Standard 1217.6-1985. Measurement is based on bottom-return air entry.
(FXDYQ) Anechoic chamber conversion value, measured at a point 1.5 m downward from the unit centre.
During actual operation, these values are normally somewhat higher as a result of ambient conditions.
- For FXDYQ models, an air filter is not a standard accessory. A suitable locally obtained filter must be installed in the return air duct.
- *1: External static pressure is changeable to change over the connectors inside electrical box, this pressure means "High static pressure-Standard-Low static pressure".
- *2: External static pressure is changeable to change over the connectors inside electrical box, this pressure means "High static pressure-Standard".
- *3: External static pressure is changeable to change over the connectors inside electrical box (High static pressure-Standard static pressure).
The data above is for high static pressure setting.

Specifications—Indoor Units

Ceiling Mounted Duct Type



MODEL		FXMQ20PVE	FXMQ25PVE	FXMQ32PVE	FXMQ40PVE	FXMQ50PVE	
Power supply		1-phase, 220-240 V/220 V, 50/60 Hz					
Cooling capacity	kcal/h(*1)	2,000	2,500	3,200	4,000	5,000	
	Btu/h(*1)	7,800	9,900	12,600	16,000	19,800	
	kW	(*1)	2.3	2.9	3.7	4.7	5.8
		(*2)	2.2	2.8	3.6	4.5	5.6
Heating capacity	kcal/h	2,200	2,800	3,400	4,300	5,400	
	Btu/h	8,500	10,900	13,600	17,100	21,500	
	kW	2.5	3.2	4.0	5.0	6.3	
Power consumption	Cooling	kW	0.081	0.081	0.085	0.194	0.215
	Heating		0.069	0.069	0.073	0.182	0.203
Casing		Galvanised steel plate					
Airflow rate (HH/H/L)	ℓ/s	150/125/108	150/125/108	158/133/116	267/216/183	300/275/250	
	m ³ /min	9/7.5/6.5	9/7.5/6.5	9.5/8/7	16/13/11	18/16.5/15	
External static pressure	Pa	30-100 *1	30-100 *1	30-100 *1	30-160 *1	50-200 *1	
Sound level (HH/H/L)	dB(A)	33/31/29	33/31/29	34/32/30	39/37/35	41/39/37	
Sound power (H)	dB(A)	51	51	52	57	59	
Dimensions (H×W×D)	mm	300×550×700	300×550×700	300×550×700	300×700×700	300×1,000×700	
Machine weight	kg	25	25	25	28	36	
Piping connections	Liquid (Flare)	mm	φ 6.4	φ 6.4	φ 6.4	φ 6.4	φ 6.4
	Gas (Flare)		φ 12.7	φ 12.7	φ 12.7	φ 12.7	φ 12.7
	Drain		VP25 (External Dia, 32/Internal Dia, 25)				

MODEL		FXMQ63PVE	FXMQ80PVE	FXMQ100PVE	FXMQ125PVE	FXMQ140PVE	
Power supply		1-phase, 220-240 V/220 V, 50/60 Hz					
Cooling capacity	kcal/h(*1)	6,300	8,000	10,000	12,500	14,300	
	Btu/h(*1)	24,900	31,700	39,600	49,500	57,000	
	kW	(*1)	7.3	9.3	11.6	14.5	16.7
		(*2)	7.1	9.0	11.2	14.0	16.0
Heating capacity	kcal/h	6,900	8,600	10,800	13,800	15,500	
	Btu/h	27,300	34,100	42,700	54,600	61,400	
	kW	8.0	10.0	12.5	16.0	18.0	
Power consumption	Cooling	kW	0.230	0.298	0.376	0.461	0.461
	Heating		0.218	0.286	0.364	0.449	0.449
Casing		Galvanised steel plate					
Airflow rate (HH/H/L)	ℓ/s	325/292/267	417/375/333	533/450/383	650/550/466	766/649/533	
	m ³ /min	19.5/17.5/16	25/22.5/20	32/27/23	39/33/28	46/39/32	
External static pressure	Pa	50-200 *1	50-200 *1	50-200 *1	50-200 *1	50-140 *1	
Sound level (HH/H/L)	dB(A)	42/40/38	43/41/39	43/41/39	44/42/40	46/45/43	
Sound power (H)	dB(A)	60	61	61	62	64	
Dimensions (H×W×D)	mm	300×1,000×700	300×1,000×700	300×1,400×700	300×1,400×700	300×1,400×700	
Machine weight	kg	36	36	46	46	47	
Piping connections	Liquid (Flare)	mm	φ 9.5	φ 9.5	φ 9.5	φ 9.5	φ 9.5
	Gas (Flare)		φ 15.9	φ 15.9	φ 15.9	φ 15.9	φ 15.9
	Drain		VP25 (External Dia, 32/Internal Dia, 25)				

Note: Specifications are based on the following conditions;

•Cooling: (*1) Indoor temp.: 27°CDB, 19.5°CWB, Outdoor temp.: 35°CDB, Equivalent piping length: 7.5 m, Level difference: 0 m.

(*2) Indoor temp.: 27°CDB, 19°CWB, Outdoor temp.: 35°CDB, Equivalent piping length: 7.5 m, Level difference: 0 m.

•Heating: Indoor temp.: 20°CDB, Outdoor temp.: 7°CDB, 6°CWB, Equivalent piping length: 7.5 m, Level difference: 0 m.

•Capacity of indoor unit is only for reference. Actual capacity of indoor unit is based on the total capacity index.

(See Engineering Data Book for details.)

•Sound level: Anechoic chamber conversion value, measured at a point 1.5 m downward from the unit centre.

During actual operation, these values are normally somewhat higher as a result of ambient conditions.

*1: External static pressure can be modified using a remote controller that offers seven (FXMQ20-32P), thirteen (FXMQ40P), fourteen (FXMQ50-125P) or ten (FXMQ140P) levels of control. These values indicate the lowest and highest possible static pressures. The standard static pressure is 50 Pa for FXMQ20-32P and 100 Pa for FXMQ40-140P.

Ceiling Mounted Duct Type

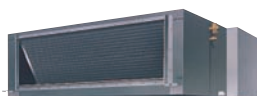

MODEL			FXMQ200MAVE	FXMQ250MAVE
Power supply			1-phase, 220-240 V/220 V, 50/60 Hz	
Cooling capacity	kcal/h (*1)		19,800	24,800
	Btu/h (*1)		78,500	98,300
	kW	(*1)	23.0	28.8
		(*2)	22.4	28.0
Heating capacity	kcal/h		21,500	27,100
	Btu/h		85,300	107,500
	kW		25.0	31.5
Power consumption	Cooling	kW	1.294	1.465
	Heating		1.294	1.465
Casing			Galvanised steel plate	
Airflow rate (H/L)	ℓ/s		966/833	1,200/1,033
	m ³ /min		58/50	72/62
External static pressure			132-221*1	191-270*1
Sound level(H/L)	240 V	dB(A)	49/46	49/46
Dimensions (H×W×D)			470×1,380×1,100	470×1,380×1,100
Machine weight			137	137
Piping connections	Liquid (Flare)	mm	φ 9.5	φ 9.5
	Gas (Brazing)		φ 19.1	φ 22.2
	Drain		PS1B	

Ceiling Suspended Type



MODEL			FXHQ32MAVE	FXHQ63MAVE	FXHQ100MAVE
Power supply			1-phase, 220-240 V/220 V, 50/60 Hz		
Cooling capacity	kcal/h (*1)		3,200	6,300	10,000
	Btu/h (*1)		12,600	24,900	39,600
	kW	(*1)	3.7	7.3	11.6
		(*2)	3.6	7.1	11.2
Heating capacity	kcal/h		3,400	6,900	10,800
	Btu/h		13,600	27,300	42,700
	kW		4.0	8.0	12.5
Power consumption	Cooling	kW	0.111	0.115	0.135
	Heating		0.111	0.115	0.135
Casing			White (10Y9/0.5)		
Airflow rate (H/L)	ℓ/s		200/166	291/233	416/325
	m ³ /min		12/10	17.5/14	25/19.5
Sound level (H/L)			36/31	39/34	45/37
Dimensions (H×W×D)			195×960×680	195×1,160×680	195×1,400×680
Machine weight			24	28	33
Piping connections	Liquid (Flare)	mm	φ 6.4	φ 9.5	φ 9.5
	Gas (Flare)		φ 12.7	φ 15.9	φ 15.9
	Drain		VP20 (External Dia, 26/Internal Dia, 20)		

Note: Specifications are based on the following conditions;

- Cooling: (*1) Indoor temp.: 27°CDB, 19.5°CWB, Outdoor temp.: 35°CDB, Equivalent piping length: 7.5 m, Level difference: 0 m.
(*2) Indoor temp.: 27°CDB, 19°CWB, Outdoor temp.: 35°CDB, Equivalent piping length: 7.5 m, Level difference: 0 m.
- Heating: Indoor temp.: 20°CDB, Outdoor temp.: 7°CDB, 6°CWB, Equivalent piping length: 7.5 m, Level difference: 0 m.
- Capacity of indoor unit is only for reference. Actual capacity of indoor unit is based on the total capacity index. (See Engineering Data Book for details.)
- Sound level: (FXMQ-MA) Anechoic chamber conversion value, measured at a point 1.5 m downward from the unit centre.
(FXHQ-MA) Anechoic chamber conversion value, measured at a point 1 m in front of the unit and 1 m downward.
During actual operation, these values are normally somewhat higher as a result of ambient conditions.

*1: External static pressure is changeable to change over the connectors inside electrical box, this pressure means "Standard-High static pressure".

Specifications—Indoor Units

Wall Mounted Type



MODEL		FXAQ20PVE	FXAQ25PVE	FXAQ32PVE	FXAQ40PVE	FXAQ50PVE	FXAQ63PVE	
Power supply		1-phase, 220-240 V/220 V, 50/60 Hz						
Cooling capacity	kcal/h (*1)	2,000	2,500	3,200	4,000	5,000	6,300	
	Btu/h (*1)	7,800	9,900	12,600	16,000	19,800	24,900	
	kW	(*1)	2.3	2.9	3.7	4.7	5.8	7.3
		(*2)	2.2	2.8	3.6	4.5	5.6	7.1
Heating capacity	kcal/h	2,200	2,800	3,400	4,300	5,400	6,900	
	Btu/h	8,500	10,900	13,600	17,100	21,500	27,300	
	kW	2.5	3.2	4.0	5.0	6.3	8.0	
Power consumption	Cooling	kW	0.019	0.028	0.030	0.020	0.033	0.050
	Heating		0.029	0.034	0.035	0.020	0.039	0.060
Casing		White (3.0Y8.5/0.5)						
Airflow rate (H/L)	ℓ/s	125/75	133/83	142/91	200/150	250/200	316/233	
	m ³ /min	7.5/4.5	8/5	8.5/5.5	12/9	15/12	19/14	
Sound level (H/L)	dB(A)	35/31	36/31	38/31	39/34	42/37	47/41	
Dimensions (H×W×D)	mm	290×795×238	290×795×238	290×795×238	290×1,050×238	290×1,050×238	290×1,050×238	
Machine weight	kg	11	11	11	14	14	14	
Piping connections	Liquid (Flare)	mm	φ6.4	φ6.4	φ6.4	φ6.4	φ6.4	φ9.5
	Gas (Flare)		φ12.7	φ12.7	φ12.7	φ12.7	φ12.7	φ15.9
	Drain		VP13 (External Dia, 18/Internal Dia, 13)					

Floor Standing Type/Concealed Floor Standing Type



FXLQ

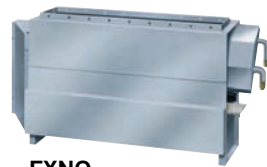

FXNQ

MODEL		FXLQ20MAVE	FXLQ25MAVE	FXLQ32MAVE	FXLQ40MAVE	FXLQ50MAVE	FXLQ63MAVE	
		FXNQ20MAVE	FXNQ25MAVE	FXNQ32MAVE	FXNQ40MAVE	FXNQ50MAVE	FXNQ63MAVE	
Power supply		1-phase, 220-240 V/220 V, 50/60 Hz						
Cooling capacity	kcal/h (*1)	2,000	2,500	3,200	4,000	5,000	6,300	
	Btu/h (*1)	7,800	9,900	12,600	16,000	19,800	24,900	
	kW	(*1)	2.3	2.9	3.7	4.7	5.8	7.3
		(*2)	2.2	2.8	3.6	4.5	5.6	7.1
Heating capacity	kcal/h	2,200	2,800	3,400	4,300	5,400	6,900	
	Btu/h	8,500	10,900	13,600	17,100	21,500	27,300	
	kW	2.5	3.2	4.0	5.0	6.3	8.0	
Power consumption	Cooling	kW	0.049	0.049	0.090	0.090	0.110	0.110
	Heating		0.049	0.049	0.090	0.090	0.110	0.110
Casing		FXLQ:Ivory white (5Y7.5/1) / FXNQ:Galvanised steel plate						
Airflow rate (H/L)	ℓ/s	116/100	116/100	133/100	183/141	233/183	266/200	
	m ³ /min	7/6	7/6	8/6	11/8.5	14/11	16/12	
Sound level (H/L)	240 V	dB(A)	37/34	37/34	37/34	40/35	41/36	42/37
Dimensions (H×W×D)	FXLQ	mm	600×1,000×222	600×1,000×222	600×1,140×222	600×1,140×222	600×1,420×222	600×1,420×222
	FXNQ		610×930×220	610×930×220	610×1,070×220	610×1,070×220	610×1,350×220	610×1,350×220
Machine weight	FXLQ	kg	25	25	30	30	36	36
	FXNQ		19	19	23	23	27	27
Piping connections	Liquid (Flare)	mm	φ6.4	φ6.4	φ6.4	φ6.4	φ6.4	φ9.5
	Gas (Flare)		φ12.7	φ12.7	φ12.7	φ12.7	φ12.7	φ15.9
	Drain		φ210.D.					

Note: Specifications are based on the following conditions:

•Cooling: (*1) Indoor temp.: 27°CDB, 19.5°CWB, Outdoor temp.: 35°CDB, Equivalent piping length: 7.5 m, Level difference: 0 m.
 (*2) Indoor temp.: 27°CDB, 19°CWB, Outdoor temp.: 35°CDB, Equivalent piping length: 7.5 m, Level difference: 0 m.

•Heating: Indoor temp.: 20°CDB, Outdoor temp.: 7°CDB, 6°CWB, Equivalent piping length: 7.5 m, Level difference: 0 m.

•Capacity of indoor unit is only for reference. Actual capacity of indoor unit is based on the total capacity index.

(See Engineering Data Book for details.)

•Sound level: (FXAQ-P) Anechoic chamber conversion value, measured at a point 1 m in front of the unit and 1 m downward.

(FXLQ-MA, FXNQ-MA) Anechoic chamber conversion value, measured at a point 1.5 m in front of the unit at a height of 1.5 m. During actual operation, these values are normally somewhat higher as a result of ambient conditions.

— Connection unit series indoor units

- * A type of BEV unit is necessary for each Connection unit series indoor unit. Refer to the Engineering Data Book for details.
- * If indoor units from the Connection unit series are connected within a single refrigerant system to indoor units from any other series, cooling/heating switchover will not be possible using the remote controller of the Connection unit series indoor units. However, if the remote controller of an indoor unit from the other series is set as a master remote controller, cooling/heating switchover will be possible.
- * If all indoor units are from the Connection unit series, an outdoor unit Cool/Heat selector will be needed to enable cooling/heating switchover.
- * Group control between Connection Unit series equipment within one system is possible. However, group control with the other VRV indoor units is not possible.

Ceiling Suspended Cassette Type (For heat pump models only)



MODEL	Indoor unit		FXUQ71MAV1	FXUQ100MAV1	FXUQ125MAV1		
	Connection unit		BEVQ71MAVE	BEVQ100MAVE	BEVQ125MAVE		
Power supply			1-phase, 220-240 V, 50 Hz				
Cooling capacity			Kcal/h(*1)	7,100	10,000	12,500	
			Btu/h(*1)	28,300	39,600	49,500	
			kW	(*1)	8.3	11.6	14.5
				(*2)	8.0	11.2	14.0
Heating capacity (Max.)			Kcal/h	7,700	10,800	12,000	
			Btu/h	30,700	42,700	47,800	
			kW	9.0	12.5	14.0	
Power consumption	Cooling	kW	0.189	0.298	0.298		
	Heating		0.169	0.278	0.278		
Casing			White(10Y9/0.5)				
Indoor unit	Airflow rate (H/L)		ℓ/s	316/233	483/350	533/383	
			m ³ /min	19/14	29/21	32/23	
	Sound level (H/L)	230 V	dB(A)	40/35	43/38	44/39	
	Sound power (H)		dB(A)	56	59	60	
	Dimensions (H×W×D)		mm	165×895×895	230×895×895	230×895×895	
	Machine weight		kg	25	31	31	
Piping connections		Liquid	φ 9.5 (Flare)				
		Gas	φ 15.9 (Flare)				
		Drain	VP 20 (External Dia. 26/Internal Dia. 20)				

Note: Specifications are based on the following conditions;

- Cooling: (*1) Indoor temp.: 27°CDB, 19.5°CWB, Outdoor temp.: 35°CDB, Equivalent piping length: 7.5 m, Level difference: 0 m.
(*2) Indoor temp.: 27°CDB, 19°CWB, Outdoor temp.: 35°CDB, Equivalent piping length: 7.5 m, Level difference: 0 m.
- Heating: Indoor temp.: 20°CDB, Outdoor temp.: 7°CDB, 6°CWB, Equivalent piping length: 7.5 m, Level difference: 0 m.
- Capacity of indoor unit is only for reference. Actual capacity of indoor unit is based on the total capacity index. (See Engineering Data Book for details.)
- Sound level: Anechoic chamber conversion value, measured at a point 1.5 m below the unit centre.
During actual operation, these values are normally somewhat higher as a result of ambient conditions.

Cooling Only

Standard Model (Space Saving Type)

MODEL		RXQ5PAY1	RXQ8PAY1	RXQ10PAY1	RXQ12PAY1	RXQ14PAY1	RXQ16PAY1	RXQ18PAY1	
Power supply		3-phase 4-wire system, 380-415 V, 50 Hz							
Cooling capacity (*1)(*2)	kcal/h (*1)	12,100	19,400	24,300	29,000	34,600	39,000	42,400	
	Btu/h (*1)	48,100	76,800	96,200	115,000	137,000	155,000	168,000	
	kW	(*1)	14.1	22.5	28.2	33.7	40.2	45.3	49.3
(*2)		14.0	22.4	28.0	33.5	40.0	45.0	49.0	
Power consumption (*2)	kW	3.52	5.24	7.90	8.93	12.4	14.2	16.4	
Capacity control	%	28-100	20-100	14-100	14-100	10-100	10-100	9-100	
Casing colour		Ivory white (5Y7.5/1)							
Compressor	Type	Hermetically sealed scroll type							
	Motor output	kW	2.2×1	3.6×1	(1.4+4.5)×1	(1.8+4.5)×1	(1.4+4.5+4.5)×1	(2.7+4.5+4.5)×1	(2.8+4.5+4.5)×1
Airflow rate	ℓ/s	1,583	3,000	3,083	3,883	3,883	3,883	3,983	
	m ³ /min	95	180	185	233	233	233	239	
Dimensions(H×W×D)	mm	1,680×635×765	1,680×930×765		1,680×1,240×765				
Machine weight	kg	160	205	249	285	329	329	341	
Sound level	dB(A)	54	57	58	60	60	60	63	
Sound power	dB(A)	72	78	78	80	80	80	83	
Operation range	°CDB	-5 to 43							
Refrigerant	Type	R-410A							
	Charge	kg	6.2	7.2	7.9	9.5	11.3	11.5	11.7
Piping connections	Liquid	mm	φ 9.5 (Brazing)	φ 9.5 (Brazing)	φ 9.5 (Brazing)	φ 12.7 (Brazing)	φ 12.7 (Brazing)	φ 12.7 (Brazing)	φ 15.9 (Brazing)
	Gas	mm	φ 15.9 (Brazing)	φ 19.1 (Brazing)	φ 22.2 (Brazing)	φ 28.6 (Brazing)	φ 28.6 (Brazing)	φ 28.6 (Brazing)	φ 28.6 (Brazing)

MODEL	Combination units	RXQ20PAY1	RXQ22PAY1	RXQ24PAY1	RXQ26PAY1	RXQ28PAY1	RXQ30PAY1	RXQ32PAY1	
		RXQ8PAY1 RXQ12PAY1	RXQ10PAY1 RXQ12PAY1	RXQ8PAY1 RXQ16PAY1	RXQ8PAY1 RXQ18PAY1	RXQ10PAY1 RXQ18PAY1	RXQ12PAY1 RXQ18PAY1	RXQ16PAY1 RXQ16PAY1	
Power supply		3-phase 4-wire system, 380-415 V, 50 Hz							
Cooling capacity (*1)(*2)	kcal/h (*1)	48,300	53,200	58,300	61,700	66,700	71,400	77,800	
	Btu/h (*1)	192,000	211,000	231,000	250,000	264,000	283,000	309,000	
	kW	(*1)	56.2	61.9	67.8	71.8	77.5	83.0	90.5
(*2)		55.9	61.5	67.4	71.4	77.0	82.5	90.0	
Power consumption (*2)	kW	14.2	16.8	19.4	21.6	24.3	25.3	28.4	
Capacity control	%	8-100	7-100	6-100	6-100	5-100	5-100	5-100	
Casing colour		Ivory white (5Y7.5/1)							
Compressor	Type	Hermetically sealed scroll type							
	Motor output	kW	(3.6×1)+ ((1.8+4.5)×1)	((1.4+4.5)×1)+ ((1.8+4.5)×1)	(3.6×1)+ ((2.7+4.5+4.5)×1)	(3.6×1)+ ((2.8+4.5+4.5)×1)	((1.4+4.5)×1)+ ((2.8+4.5+4.5)×1)	((1.8+4.5)×1)+ ((2.8+4.5+4.5)×1)	((2.7+4.5+4.5)×1)+ ((2.7+4.5+4.5)×1)
Airflow rate	ℓ/s	3,000+3,883	3,083+3,883	3,000+3,883	3,000+3,983	3,083+3,983	3,883+3,983	3,883+3,883	
	m ³ /min	180+233	185+233	180+233	180+239	185+239	233+239	233+233	
Dimensions(H×W×D)	mm	(1,680×930×765)+(1,680×1,240×765)					(1,680×1,240×765)+(1,680×1,240×765)		
Machine weight	kg	205+285	249+285	205+329	205+341	249+341	285+341	329+329	
Sound level	dB(A)	62	62	62	64	64	65	63	
Sound power	dB(A)	83	83	83	85	85	85	83	
Operation range	°CDB	-5 to 43							
Refrigerant	Type	R-410A							
	Charge	kg	7.2+9.5	7.9+9.5	7.2+11.5	7.2+11.7	7.9+11.7	9.5+11.7	11.5+11.5
Piping connections	Liquid	mm	φ 15.9 (Brazing)	φ 15.9 (Brazing)	φ 15.9 (Brazing)	φ 19.1 (Brazing)	φ 19.1 (Brazing)	φ 19.1 (Brazing)	φ 19.1 (Brazing)
	Gas	mm	φ 28.6 (Brazing)	φ 28.6 (Brazing)	φ 34.9 (Brazing)	φ 34.9 (Brazing)	φ 34.9 (Brazing)	φ 34.9 (Brazing)	φ 34.9 (Brazing)

Note: Specifications are based on the following conditions;

•Cooling: (*1) Indoor temp.: 27°CDB, 19.5°CWB, Outdoor temp.: 35°CDB, Equivalent piping length: 7.5 m, Level difference: 0 m.

(*2) Indoor temp.: 27°CDB, 19°CWB, Outdoor temp.: 35°CDB, Equivalent piping length: 7.5 m, Level difference: 0 m.

•Sound level: Anechoic chamber conversion value, measured at a point 1 m in front of the unit at a height of 1.5 m.
During actual operation, these values are normally somewhat higher as a result of ambient conditions.

Standard Model (Space Saving Type)

MODEL	Combination units		RXQ34PAY1	RXQ36PAY1	RXQ38PAY1	RXQ40PAY1	RXQ42PAY1	RXQ44PAY1
			RXQ16PAY1 RXQ18PAY1	RXQ18PAY1 RXQ18PAY1	RXQ8PAY1 RXQ12PAY1 RXQ18PAY1	RXQ8PAY1 RXQ16PAY1 RXQ16PAY1	RXQ8PAY1 RXQ16PAY1 RXQ18PAY1	RXQ8PAY1 RXQ18PAY1 RXQ18PAY1
Power supply			3-phase 4-wire system, 380-415 V, 50 Hz					
Cooling capacity (*1)(*2)	kcal/h (*1)		81,400	85,100	91,200	97,200	101,000	104,000
		Btu/h (*1)	323,000	338,000	362,000	386,000	399,000	413,000
	kW	(*1)	94.6	99.0	106	113	117	121
(*2)		94.0	98.0	105	112	116	120	
Power consumption (*2)	kW		30.6	32.8	30.6	33.6	35.8	38.0
Capacity control	%		5-100	4-100	4-100	4-100	4-100	4-100
Casing colour			Ivory white (5Y7.5/1)					
Compressor	Type		Hermetically sealed scroll type					
	Motor output	kW	$\frac{((2.7+4.5+4.5) \times 1) + ((2.8+4.5+4.5) \times 1)}{((2.8+4.5+4.5) \times 1)}$	$\frac{((2.8+4.5+4.5) \times 1) + ((2.8+4.5+4.5) \times 1)}{((2.8+4.5+4.5) \times 1)}$	$\frac{(3.6 \times 1) + ((1.8+4.5) \times 1) + ((2.8+4.5+4.5) \times 1)}{((2.8+4.5+4.5) \times 1)}$	$\frac{(3.6 \times 1) + ((2.7+4.5+4.5) \times 1) + ((2.7+4.5+4.5) \times 1)}{((2.7+4.5+4.5) \times 1)}$	$\frac{(3.6 \times 1) + ((2.7+4.5+4.5) \times 1) + ((2.8+4.5+4.5) \times 1)}{((2.8+4.5+4.5) \times 1)}$	$\frac{(3.6 \times 1) + ((2.8+4.5+4.5) \times 1) + ((2.8+4.5+4.5) \times 1)}{((2.8+4.5+4.5) \times 1)}$
Airflow rate	ℓ/s		3,883+3,983	3,983+3,983	3,000+3,883+3,983	3,000+3,883+3,883	3,000+3,883+3,983	3,000+3,983+3,983
	m ³ /min		233+239	239+239	180+233+239	180+233+233	180+233+239	180+239+239
Dimensions(H×W×D)	mm		(1,680×1,240×765)+(1,680×1,240×765)		(1,680×930×765)+(1,680×1,240×765)+(1,680×1,240×765)			
Machine weight	kg		329+341	341+341	205+285+341	205+329+329	205+329+341	205+341+341
Sound level	dB(A)		65	66	65	64	65	67
Sound power	dB(A)		85	86	85	85	85	87
Operation range	°CDB		-5 to 43					
Refrigerant	Type		R-410A					
	Charge	kg	11.5+11.7	11.7+11.7	7.2+9.5+11.7	7.2+11.5+11.5	7.2+11.5+11.7	7.2+11.7+11.7
Piping connections	Liquid	mm	φ 19.1 (Brazing)	φ 19.1 (Brazing)	φ 19.1 (Brazing)	φ 19.1 (Brazing)	φ 19.1 (Brazing)	φ 19.1 (Brazing)
	Gas		φ 34.9 (Brazing)	φ 41.3 (Brazing)	φ 41.3 (Brazing)	φ 41.3 (Brazing)	φ 41.3 (Brazing)	φ 41.3 (Brazing)

MODEL	Combination units		RXQ46PAY1	RXQ48PAY1	RXQ50PAY1	RXQ52PAY1	RXQ54PAY1	
			RXQ10PAY1 RXQ18PAY1 RXQ18PAY1	RXQ12PAY1 RXQ18PAY1 RXQ18PAY1	RXQ14PAY1 RXQ18PAY1 RXQ18PAY1	RXQ16PAY1 RXQ18PAY1 RXQ18PAY1	RXQ18PAY1 RXQ18PAY1 RXQ18PAY1	
Power supply			3-phase 4-wire system, 380-415 V, 50 Hz					
Cooling capacity (*1)(*2)	kcal/h (*1)		109,000	114,000	120,000	124,000	127,000	
		Btu/h (*1)	433,000	454,000	474,000	491,000	505,000	
	kW	(*1)	127	133	139	144	148	
(*2)		126	132	138	143	147		
Power consumption (*2)	kW		40.7	41.7	45.2	47.0	49.2	
Capacity control	%		3-100	3-100	3-100	3-100	3-100	
Casing colour			Ivory white (5Y7.5/1)					
Compressor	Type		Hermetically sealed scroll type					
	Motor output	kW	$\frac{((1.4+4.5) \times 1) + ((2.8+4.5+4.5) \times 1) + ((2.8+4.5+4.5) \times 1)}{((2.8+4.5+4.5) \times 1)}$	$\frac{((1.8+4.5) \times 1) + ((2.8+4.5+4.5) \times 1) + ((2.8+4.5+4.5) \times 1)}{((2.8+4.5+4.5) \times 1)}$	$\frac{((1.4+4.5+4.5) \times 1) + ((2.8+4.5+4.5) \times 1) + ((2.8+4.5+4.5) \times 1)}{((2.8+4.5+4.5) \times 1)}$	$\frac{((2.7+4.5+4.5) \times 1) + ((2.8+4.5+4.5) \times 1) + ((2.8+4.5+4.5) \times 1)}{((2.8+4.5+4.5) \times 1)}$	$\frac{((2.8+4.5+4.5) \times 1) + ((2.8+4.5+4.5) \times 1) + ((2.8+4.5+4.5) \times 1)}{((2.8+4.5+4.5) \times 1)}$	
Airflow rate	ℓ/s		3,083+3,983+3,983	3,883+3,983+3,983	3,883+3,983+3,983	3,883+3,983+3,983	3,983+3,983+3,983	
	m ³ /min		185+239+239	233+239+239	233+239+239	233+239+239	239+239+239	
Dimensions(H×W×D)	mm		(1,680×930×765)+(1,680×1,240×765)+(1,680×1,240×765)		(1,680×1,240×765)+(1,680×1,240×765)+(1,680×1,240×765)			
Machine weight	kg		249+341+341	285+341+341	329+341+341	329+341+341	341+341+341	
Sound level	dB(A)		67	67	67	67	68	
Sound power	dB(A)		87	87	87	87	88	
Operation range	°CDB		-5 to 43					
Refrigerant	Type		R-410A					
	Charge	kg	7.9+11.7+11.7	9.5+11.7+11.7	11.3+11.7+11.7	11.5+11.7+11.7	11.7+11.7+11.7	
Piping connections	Liquid	mm	φ 19.1 (Brazing)	φ 19.1 (Brazing)	φ 19.1 (Brazing)	φ 19.1 (Brazing)	φ 19.1 (Brazing)	
	Gas		φ 41.3 (Brazing)	φ 41.3 (Brazing)	φ 41.3 (Brazing)	φ 41.3 (Brazing)	φ 41.3 (Brazing)	

Note: Specifications are based on the following conditions;

•Cooling: (*1) Indoor temp.: 27°CDB, 19.5°CWB, Outdoor temp.: 35°CDB, Equivalent piping length: 7.5 m, Level difference: 0 m.

(*2) Indoor temp.: 27°CDB, 19°CWB, Outdoor temp.: 35°CDB, Equivalent piping length: 7.5 m, Level difference: 0 m.

•Sound level: Anechoic chamber conversion value, measured at a point 1 m in front of the unit at a height of 1.5 m.

During actual operation, these values are normally somewhat higher as a result of ambient conditions.

Specifications—Outdoor Units

Cooling Only

High Efficiency Model (Energy Saving Type)

MODEL	Combination units	RXQ16PAHY1	RXQ18PAHY1	RXQ24PAHY1	RXQ26PAHY1	RXQ28PAHY1	RXQ30PAHY1	RXQ32PAHY1	
		RXQ8PAY1 RXQ8PAY1	RXQ8PAY1 RXQ10PAY1	RXQ8PAY1 RXQ8PAY1 RXQ8PAY1	RXQ8PAY1 RXQ8PAY1 RXQ10PAY1	RXQ8PAY1 RXQ8PAY1 RXQ12PAY1	RXQ8PAY1 RXQ10PAY1 RXQ12PAY1	RXQ8PAY1 RXQ12PAY1 RXQ12PAY1	
Power supply		3-phase 4-wire system, 380-415 V, 50 Hz							
Cooling capacity (*1)(*2)	kcal/h (*1)	38,800	43,600	58,100	63,000	67,800	72,600	77,300	
	Btu/h (*1)	154,000	173,000	231,000	250,000	269,000	288,000	307,000	
	kW	(*1)	45.1	50.7	67.6	73.2	78.8	84.4	89.9
(*2)		44.8	50.4	67.2	72.8	78.3	83.9	89.4	
Power consumption (*2)	kW	10.5	13.1	15.7	18.4	19.4	22.1	23.1	
Capacity control	%	10-100	8-100	7-100	6-100	6-100	5-100	5-100	
Casing colour		Ivory white (5Y7.5/1)							
Compressor	Type	Hermetically sealed scroll type							
	Motor output	kW	(3.6×1)+(3.6×1)	(3.6×1)+((1.4+4.5)×1)	(3.6×1)+(3.6×1)+ (3.6×1)	(3.6×1)+(3.6×1)+ ((1.4+4.5)×1)	(3.6×1)+(3.6×1)+ ((1.8+4.5)×1)	(3.6×1)+((1.4+4.5)×1)+ ((1.8+4.5)×1)	(3.6×1)+((1.8+4.5)×1)+ ((1.8+4.5)×1)
Airflow rate	ℓ/s	3,000+3,000	3,000+3,083	3,000+3,000+3,000	3,000+3,000+3,083	3,000+3,000+3,883	3,000+3,083+3,883	3,000+3,883+3,883	
	m ³ /min	180+180	180+185	180+180+180	180+180+185	180+180+233	180+185+233	180+233+233	
Dimensions(H×W×D)	mm	(1,680×930×765)+(1,680×930×765)		(1,680×930×765)+(1,680×930×765)+ (1,680×930×765)		(1,680×930×765)+(1,680×930×765)+ (1,680×1,240×765)		(1,680×930×765)+ (1,680×1,240×765)+ (1,680×1,240×765)	
Machine weight	kg	205+205	205+249	205+205+205	205+205+249	205+205+285	205+249+285	205+285+285	
Sound level	dB(A)	60	61	62	62	63	63	64	
Sound power	dB(A)	81	81	83	83	83	83	85	
Operation range	°CDB	-5 to 43							
Refrigerant	Type	R-410A							
	Charge	kg	7.2+7.2	7.2+7.9	7.2+7.2+7.2	7.2+7.2+7.9	7.2+7.2+9.5	7.2+7.9+9.5	7.2+9.5+9.5
Piping connections	Liquid	mm	φ12.7 (Brazeing)	φ15.9 (Brazeing)	φ15.9 (Brazeing)	φ19.1 (Brazeing)	φ19.1 (Brazeing)	φ19.1 (Brazeing)	φ19.1 (Brazeing)
	Gas	mm	φ28.6 (Brazeing)	φ28.6 (Brazeing)	φ34.9 (Brazeing)	φ34.9 (Brazeing)	φ34.9 (Brazeing)	φ34.9 (Brazeing)	φ34.9 (Brazeing)

MODEL	Combination units	RXQ34PAHY1	RXQ36PAHY1	RXQ38PAHY1	RXQ40PAHY1	RXQ42PAHY1	RXQ44PAHY1	
		RXQ10PAY1 RXQ12PAY1 RXQ12PAY1	RXQ12PAY1 RXQ12PAY1 RXQ12PAY1	RXQ12PAY1 RXQ12PAY1 RXQ14PAY1	RXQ12PAY1 RXQ12PAY1 RXQ16PAY1	RXQ12PAY1 RXQ12PAY1 RXQ18PAY1	RXQ12PAY1 RXQ16PAY1 RXQ16PAY1	
Power supply		3-phase 4-wire system, 380-415 V, 50 Hz						
Cooling capacity (*1)(*2)	kcal/h (*1)	82,200	87,700	92,900	97,200	101,000	108,000	
	Btu/h (*1)	326,000	348,000	368,000	386,000	399,000	427,000	
	kW	(*1)	95.6	102	108	113	117	125
(*2)		95.0	101	107	112	116	124	
Power consumption (*2)	kW	25.8	26.8	30.3	32.1	34.3	37.3	
Capacity control	%	5-100	5-100	4-100	4-100	4-100	4-100	
Casing colour		Ivory white (5Y7.5/1)						
Compressor	Type	Hermetically sealed scroll type						
	Motor output	kW	((1.4+4.5)×1)+((1.8+4.5)×1)+ ((1.8+4.5)×1)	((1.8+4.5)×1)+((1.8+4.5)×1)+ ((1.8+4.5)×1)	((1.8+4.5)×1)+((1.8+4.5)×1)+ ((1.4+4.5+4.5)×1)	((1.8+4.5)×1)+((1.8+4.5)×1)+ ((2.7+4.5+4.5)×1)	((1.8+4.5)×1)+((1.8+4.5)×1)+ ((2.8+4.5+4.5)×1)	((1.8+4.5)×1)+((2.7+4.5+4.5)×1)+ ((2.7+4.5+4.5)×1)
Airflow rate	ℓ/s	3,083+3,883+3,883	3,883+3,883+3,883	3,883+3,883+3,883	3,883+3,883+3,883	3,883+3,883+3,983	3,883+3,883+3,883	
	m ³ /min	185+233+233	233+233+233	233+233+233	233+233+233	233+233+239	233+233+233	
Dimensions(H×W×D)	mm	(1,680×930×765)+ (1,680×1,240×765)+ (1,680×1,240×765)	(1,680×1,240×765)+(1,680×1,240×765)+(1,680×1,240×765)					
Machine weight	kg	249+285+285	285+285+285	285+285+329	285+285+329	285+285+341	285+329+329	
Sound level	dB(A)	64	65	65	65	66	65	
Sound power	dB(A)	85	85	85	85	86	85	
Operation range	°CDB	-5 to 43						
Refrigerant	Type	R-410A						
	Charge	kg	7.9+9.5+9.5	9.5+9.5+9.5	9.5+9.5+11.3	9.5+9.5+11.5	9.5+9.5+11.7	9.5+11.5+11.5
Piping connections	Liquid	mm	φ19.1 (Brazeing)	φ19.1 (Brazeing)	φ19.1 (Brazeing)	φ19.1 (Brazeing)	φ19.1 (Brazeing)	φ19.1 (Brazeing)
	Gas	mm	φ34.9 (Brazeing)	φ41.3 (Brazeing)	φ41.3 (Brazeing)	φ41.3 (Brazeing)	φ41.3 (Brazeing)	φ41.3 (Brazeing)

Note: Specifications are based on the following conditions;

•Cooling: (*1) Indoor temp.: 27°CDB, 19.5°CWB, Outdoor temp.: 35°CDB, Equivalent piping length: 7.5 m, Level difference: 0 m.

(*2) Indoor temp.: 27°CDB, 19°CWB, Outdoor temp.: 35°CDB, Equivalent piping length: 7.5 m, Level difference: 0 m.

•Sound level: Anechoic chamber conversion value, measured at a point 1 m in front of the unit at a height of 1.5 m.

During actual operation, these values are normally somewhat higher as a result of ambient conditions.

High Efficiency Model (Energy Saving Type)

MODEL	Combination units		RXQ46PAHY1	RXQ48PAHY1	RXQ50PAHY1
			RXQ12PAY1 RXQ16PAY1 RXQ18PAY1	RXQ16PAY1 RXQ16PAY1 RXQ16PAY1	RXQ16PAY1 RXQ16PAY1 RXQ18PAY1
Power supply			3-phase 4-wire system, 380-415 V, 50 Hz		
Cooling capacity (*1)(*2)	kcal/h (*1)		111,000	117,000	120,000
	Btu/h (*1)		440,000	464,000	478,000
	kW	(*1)		129	136
(*2)			128	135	139
Power consumption (*2)	kW		39.5	42.6	44.8
Capacity control	%		3-100	3-100	3-100
Casing colour			Ivory white (5Y7.5/1)		
Compressor	Type		Hermetically sealed scroll type		
	Motor output	kW	$((1.8+4.5)\times 1)+((2.7+4.5+4.5)\times 1)+((2.8+4.5+4.5)\times 1)$	$((2.7+4.5+4.5)\times 1)+((2.7+4.5+4.5)\times 1)+((2.7+4.5+4.5)\times 1)$	$((2.7+4.5+4.5)\times 1)+((2.7+4.5+4.5)\times 1)+((2.8+4.5+4.5)\times 1)$
Airflow rate	ℓ/s		3,883+3,883+3,983	3,883+3,883+3,883	3,883+3,883+3,983
	m ³ /min		233+233+239	233+233+233	233+233+239
Dimensions(H×W×D)	mm		(1,680×1,240×765)+(1,680×1,240×765)+(1,680×1,240×765)		
Machine weight	kg		285+329+341	329+329+329	329+329+341
Sound level	dB(A)		66	65	66
Sound power	dB(A)		86	85	86
Operation range	°CDB		-5 to 43		
Refrigerant	Type		R-410A		
	Charge	kg	9.5+11.5+11.7	11.5+11.5+11.5	11.5+11.5+11.7
Piping connections	Liquid	mm	φ 19.1 (Brazing)	φ 19.1 (Brazing)	φ 19.1 (Brazing)
	Gas		φ 41.3 (Brazing)	φ 41.3 (Brazing)	φ 41.3 (Brazing)

Note: Specifications are based on the following conditions:

- Cooling: (*1) Indoor temp.: 27°CDB, 19.5°CWB, Outdoor temp.: 35°CDB, Equivalent piping length: 7.5 m, Level difference: 0 m.
(*2) Indoor temp.: 27°CDB, 19°CWB, Outdoor temp.: 35°CDB, Equivalent piping length: 7.5 m, Level difference: 0 m.
- Sound level: Anechoic chamber conversion value, measured at a point 1 m in front of the unit at a height of 1.5 m.
During actual operation, these values are normally somewhat higher as a result of ambient conditions.

Heat Pump

Standard Model (Space Saving Type)

MODEL		RXYQ5PAY1(E)	RXYQ6PAY1	RXYQ8PAY1(E)	RXYQ10PAY1(E)	RXYQ12PAY1(E)	RXYQ14PAY1(E)	RXYQ16PAY1(E)	RXYQ18PAY1(E)	
Power supply		3-phase 4-wire system, 380-415 V, 50 Hz								
Cooling capacity (*1)(*2)	kcal/h (*1)	12,100	13,900	19,400	24,300	29,000	34,600	39,000	42,400	
	Btu/h (*1)	48,100	55,000	76,800	96,200	115,000	137,000	155,000	168,000	
	kW (*1)	14.1	16.1	22.5	28.2	33.7	40.2	45.3	49.3	
Heating capacity	kcal/h (*2)	14.0	16.0	22.4	28.0	33.5	40.0	45.0	49.0	
	kcal/h	13,800	15,500	21,500	27,100	32,300	38,700	43,000	48,600	
	Btu/h	54,600	61,400	85,300	107,000	128,000	154,000	171,000	193,000	
Power consumption	Cooling (*2)	kW	3.52	3.65	5.24	7.90	8.93	12.4	14.2	16.4
	Heating	kW	4.00	4.02	5.74	7.70	9.06	11.3	12.9	15.3
Capacity control	%	28-100	20-100	20-100	14-100	14-100	10-100	10-100	9-100	
Casing colour		Without (E): Ivory white (5Y7.5/1), With (E): Light camel (2.5Y6.5/1.5)								
Compressor	Type	Hermetically sealed scroll type								
	Motor output	kW	2.8×1	4.5×1	4.5×1	(1.4+4.5)×1	(2.5+4.5)×1	(1.6+4.5+4.5)×1	(2.7+4.5+4.5)×1	(4.3+4.5+4.5)×1
Airflow rate	ℓ/s	1,583	3,000	3,000	3,083	3,883	3,883	3,883	3,983	
	m ³ /min	95	180	180	185	233	233	233	239	
Dimensions (H×W×D)	mm	1,680×635×765	1,680×930×765			1,680×1,240×765				
Machine weight	kg	160	205	205	249	285	329	329	341	
Sound level	dB(A)	54	57	57	58	60	60	60	63	
Sound power	dB(A)	72	78	78	78	80	80	80	83	
Operation range	Cooling	°CDB	-5 to 43							
	Heating	°CWB	-20 to 15.5							
Refrigerant	Type	R-410A								
	Charge	kg	6.2	7.2	7.2	7.9	9.5	11.3	11.5	11.7
Piping connections	Liquid	mm	φ 9.5 (Brazing)	φ 9.5 (Brazing)	φ 9.5 (Brazing)	φ 9.5 (Brazing)	φ 12.7 (Brazing)	φ 12.7 (Brazing)	φ 12.7 (Brazing)	φ 15.9 (Brazing)
	Gas	mm	φ 15.9 (Brazing)	φ 19.1 (Brazing)	φ 19.1 (Brazing)	φ 22.2 (Brazing)	φ 28.6 (Brazing)	φ 28.6 (Brazing)	φ 28.6 (Brazing)	φ 28.6 (Brazing)

MODEL		Combination units	RXYQ20PAY1(E)	RXYQ22PAY1(E)	RXYQ24PAY1(E)	RXYQ26PAY1(E)	RXYQ28PAY1(E)	RXYQ30PAY1(E)	RXYQ32PAY1(E)
Power supply		3-phase 4-wire system, 380-415 V, 50 Hz							
Cooling capacity (*1)(*2)	kcal/h (*1)		48,300	53,200	58,300	61,700	66,700	71,400	77,800
	Btu/h (*1)		192,000	211,000	231,000	250,000	264,000	283,000	309,000
	kW (*1)		56.2	61.9	67.8	71.8	77.5	83.0	90.5
Heating capacity	kcal/h (*2)		55.9	61.5	67.4	71.4	77.0	82.5	90.0
	kcal/h		53,800	59,300	64,500	70,100	75,700	80,800	86,000
	Btu/h		213,000	235,000	256,000	278,000	300,000	321,000	341,000
Power consumption	Cooling (*2)	kW	14.2	16.8	19.4	21.6	24.3	25.3	28.4
	Heating	kW	14.8	16.8	18.6	21.0	23.0	24.4	25.8
Capacity control	%		8-100	7-100	6-100	6-100	5-100	5-100	5-100
Casing colour		Without (E): Ivory white (5Y7.5/1), With (E): Light camel (2.5Y6.5/1.5)							
Compressor	Type	Hermetically sealed scroll type							
	Motor output	kW	(4.5×1)+ ((2.5+4.5)×1)	((1.4+4.5)×1)+ ((2.5+4.5)×1)	(4.5×1)+ ((2.7+4.5+4.5)×1)	(4.5×1)+ ((4.3+4.5+4.5)×1)	((1.4+4.5)×1)+ ((4.3+4.5+4.5)×1)	((2.5+4.5)×1)+ ((4.3+4.5+4.5)×1)	((2.7+4.5+4.5)×1)+ ((2.7+4.5+4.5)×1)
Airflow rate	ℓ/s		3,000+3,883	3,083+3,883	3,000+3,883	3,000+3,983	3,083+3,983	3,883+3,983	3,883+3,883
	m ³ /min		180+233	185+233	180+233	180+239	185+239	233+239	233+233
Dimensions (H×W×D)	mm		(1,680×930×765)+(1,680×1,240×765)					(1,680×1,240×765)+(1,680×1,240×765)	
Machine weight	kg		205+285	249+285	205+329	205+341	249+341	285+341	329+329
Sound level	dB(A)		62	62	62	64	64	65	63
Sound power	dB(A)		83	83	83	85	85	85	83
Operation range	Cooling	°CDB	-5 to 43						
	Heating	°CWB	-20 to 15.5						
Refrigerant	Type	R-410A							
	Charge	kg	7.2+9.5	7.9+9.5	7.2+11.5	7.2+11.7	7.9+11.7	9.5+11.7	11.5+11.5
Piping connections	Liquid	mm	φ 15.9 (Brazing)	φ 15.9 (Brazing)	φ 15.9 (Brazing)	φ 19.1 (Brazing)	φ 19.1 (Brazing)	φ 19.1 (Brazing)	φ 19.1 (Brazing)
	Gas	mm	φ 28.6 (Brazing)	φ 28.6 (Brazing)	φ 34.9 (Brazing)	φ 34.9 (Brazing)	φ 34.9 (Brazing)	φ 34.9 (Brazing)	φ 34.9 (Brazing)

Note: 1. Models with (E) feature components treated for heat and rust corrosion resistance, such as external panels, fan motor, and electric component box, in addition to the fins of the heat exchanger. These models are designed specifically for use in areas which are subject to salt damage and atmospheric pollution. Please contact Daikin for more information.

2. Specifications are based on the following conditions:

•Cooling: (*1) Indoor temp.: 27°CDB, 19°CWB, Outdoor temp.: 35°CDB, Equivalent piping length: 7.5 m, Level difference: 0 m.

(*2) Indoor temp.: 27°CDB, 19°CWB, Outdoor temp.: 35°CDB, Equivalent piping length: 7.5 m, Level difference: 0 m.

•Heating: Indoor temp.: 20°CDB, Outdoor temp.: 7°CDB, 6°CWB, Equivalent piping length: 7.5 m, Level difference: 0 m.

•Sound level: Anechoic chamber conversion value, measured at a point 1 m in front of the unit at a height of 1.5 m.

During actual operation, these values are normally somewhat higher as a result of ambient conditions.

Standard Model (Space Saving Type)

MODEL	Combination units	RXYQ34PAY1(E)	RXYQ36PAY1(E)	RXYQ38PAY1(E)	RXYQ40PAY1(E)	RXYQ42PAY1(E)	RXYQ44PAY1(E)
		RXYQ16PAY1(E) RXYQ18PAY1(E)	RXYQ18PAY1(E) RXYQ18PAY1(E)	RXYQ8PAY1(E) RXYQ12PAY1(E) RXYQ18PAY1(E)	RXYQ8PAY1(E) RXYQ16PAY1(E) RXYQ16PAY1(E)	RXYQ8PAY1(E) RXYQ16PAY1(E) RXYQ18PAY1(E)	RXYQ8PAY1(E) RXYQ18PAY1(E) RXYQ18PAY1(E)
Power supply		3-phase 4-wire system, 380-415 V, 50 Hz					
Cooling capacity(*1)(*2)	kcal/h(*1)	81,400	85,100	91,200	97,200	101,000	104,000
	Btu/h(*1)	323,000	338,000	362,000	386,000	399,000	413,000
	kW	(*1)	94.6	99.0	106	113	117
(*2)		94.0	98.0	105	112	116	120
Heating capacity	kcal/h	92,000	97,200	102,000	108,000	114,000	119,000
	Btu/h	365,000	386,000	406,000	427,000	450,000	471,000
	kW	107	113	119	125	132	138
Power consumption	Cooling(*2)	30.6	32.8	30.6	33.6	35.8	38.0
	Heating	28.2	30.6	30.1	31.5	33.9	36.3
Capacity control	%	5-100	4-100	4-100	4-100	4-100	4-100
Casing colour		Without (E): Ivory white (5Y7.5/1), With (E): Light camel (2.5Y6.5/1.5)					
Compressor	Type	Hermetically sealed scroll type					
	Motor output	kW	$((2.7+4.5+4.5) \times 1) + ((4.3+4.5+4.5) \times 1)$	$((4.3+4.5+4.5) \times 1) + ((4.3+4.5+4.5) \times 1)$	$(4.5 \times 1) + ((2.5+4.5) \times 1) + ((4.3+4.5+4.5) \times 1)$	$(4.5 \times 1) + ((2.7+4.5+4.5) \times 1) + ((2.7+4.5+4.5) \times 1)$	$(4.5 \times 1) + ((2.7+4.5+4.5) \times 1) + ((4.3+4.5+4.5) \times 1)$
Airflow rate	ℓ/s	3,883+3,983	3,983+3,983	3,000+3,883+3,983	3,000+3,883+3,883	3,000+3,883+3,983	3,000+3,983+3,983
	m ³ /min	233+239	239+239	180+233+239	180+233+233	180+233+239	180+239+239
Dimensions(HxWxD)	mm	$(1,680 \times 1,240 \times 765) + (1,680 \times 1,240 \times 765)$ $(1,680 \times 930 \times 765) + (1,680 \times 1,240 \times 765) + (1,680 \times 1,240 \times 765)$					
Machine weight	kg	329+341	341+341	205+285+341	205+329+329	205+329+341	205+341+341
Sound level	dB(A)	65	66	65	64	65	67
Sound power	dB(A)	85	86	85	85	85	87
Operation range	Cooling	°CDB -5 to 43					
	Heating	°CWB -20 to 15.5					
Refrigerant	Type	R-410A					
	Charge	kg	11.5+11.7	11.7+11.7	7.2+9.5+11.7	7.2+11.5+11.5	7.2+11.5+11.7
Piping connections	Liquid	mm	φ 19.1 (Brazing)	φ 19.1 (Brazing)	φ 19.1 (Brazing)	φ 19.1 (Brazing)	φ 19.1 (Brazing)
	Gas	mm	φ 34.9 (Brazing)	φ 41.3 (Brazing)	φ 41.3 (Brazing)	φ 41.3 (Brazing)	φ 41.3 (Brazing)

MODEL	Combination units	RXYQ46PAY1(E)	RXYQ48PAY1(E)	RXYQ50PAY1(E)	RXYQ52PAY1(E)	RXYQ54PAY1(E)
		RXYQ10PAY1(E) RXYQ18PAY1(E) RXYQ18PAY1(E)	RXYQ12PAY1(E) RXYQ18PAY1(E) RXYQ18PAY1(E)	RXYQ14PAY1(E) RXYQ18PAY1(E) RXYQ18PAY1(E)	RXYQ16PAY1(E) RXYQ18PAY1(E) RXYQ18PAY1(E)	RXYQ18PAY1(E) RXYQ18PAY1(E) RXYQ18PAY1(E)
Power supply		3-phase 4-wire system, 380-415 V, 50 Hz				
Cooling capacity(*1)(*2)	kcal/h(*1)	109,000	114,000	120,000	124,000	127,000
	Btu/h(*1)	433,000	454,000	474,000	491,000	505,000
	kW	(*1)	127	133	139	144
(*2)		126	132	138	143	147
Heating capacity	kcal/h	125,000	130,000	136,000	140,000	146,000
	Btu/h	495,000	515,000	539,000	556,000	580,000
	kW	145	151	158	163	170
Power consumption	Cooling(*2)	40.7	41.7	45.2	47.0	49.2
	Heating	38.3	39.7	41.9	43.5	45.9
Capacity control	%	3-100	3-100	3-100	3-100	3-100
Casing colour		Without (E): Ivory white (5Y7.5/1), With (E): Light camel (2.5Y6.5/1.5)				
Compressor	Type	Hermetically sealed scroll type				
	Motor output	kW	$((1.4+4.5) \times 1) + ((4.3+4.5+4.5) \times 1) + ((4.3+4.5+4.5) \times 1)$	$((2.5+4.5) \times 1) + ((4.3+4.5+4.5) \times 1) + ((4.3+4.5+4.5) \times 1)$	$((1.6+4.5+4.5) \times 1) + ((4.3+4.5+4.5) \times 1) + ((4.3+4.5+4.5) \times 1)$	$((2.7+4.5+4.5) \times 1) + ((4.3+4.5+4.5) \times 1) + ((4.3+4.5+4.5) \times 1)$
Airflow rate	ℓ/s	3,083+3,983+3,983	3,883+3,983+3,983	3,883+3,983+3,983	3,883+3,983+3,983	3,983+3,983+3,983
	m ³ /min	185+239+239	233+239+239	233+239+239	233+239+239	239+239+239
Dimensions(HxWxD)	mm	$(1,680 \times 930 \times 765) + (1,680 \times 1,240 \times 765) + (1,680 \times 1,240 \times 765)$ $(1,680 \times 1,240 \times 765) + (1,680 \times 1,240 \times 765) + (1,680 \times 1,240 \times 765)$				
Machine weight	kg	249+341+341	285+341+341	329+341+341	329+341+341	341+341+341
Sound level	dB(A)	67	67	67	67	68
Sound power	dB(A)	87	87	87	87	88
Operation range	Cooling	°CDB -5 to 43				
	Heating	°CWB -20 to 15.5				
Refrigerant	Type	R-410A				
	Charge	kg	7.9+11.7+11.7	9.5+11.7+11.7	11.3+11.7+11.7	11.5+11.7+11.7
Piping connections	Liquid	mm	φ 19.1 (Brazing)	φ 19.1 (Brazing)	φ 19.1 (Brazing)	φ 19.1 (Brazing)
	Gas	mm	φ 41.3 (Brazing)	φ 41.3 (Brazing)	φ 41.3 (Brazing)	φ 41.3 (Brazing)

Note: 1. Models with (E) feature components treated for heat and rust corrosion resistance, such as external panels, fan motor, and electric component box, in addition to the fins of the heat exchanger. These models are designed specifically for use in areas which are subject to salt damage and atmospheric pollution. Please contact Daikin for more information.

2. Specifications are based on the following conditions:

•Cooling: (*1) Indoor temp.: 27°CDB, 19°CWB, Outdoor temp.: 35°CDB, Equivalent piping length: 7.5 m, Level difference: 0 m.

(*2) Indoor temp.: 27°CDB, 19°CWB, Outdoor temp.: 35°CDB, Equivalent piping length: 7.5 m, Level difference: 0 m.

•Heating: Indoor temp.: 20°CDB, Outdoor temp.: 7°CDB, 6°CWB, Equivalent piping length: 7.5 m, Level difference: 0 m.

•Sound level: Anechoic chamber conversion value, measured at a point 1 m in front of the unit at a height of 1.5 m.

During actual operation, these values are normally somewhat higher as a result of ambient conditions.

Heat Pump

High Efficiency Model (Energy Saving Type)

MODEL	Combination units	RXYQ16PAHY1(E)	RXYQ18PAHY1(E)	RXYQ24PAHY1(E)	RXYQ26PAHY1(E)	RXYQ28PAHY1(E)	RXYQ30PAHY1(E)	RXYQ32PAHY1(E)	
		RXYQ8PAY1(E) RXYQ8PAY1(E)	RXYQ8PAY1(E) RXYQ10PAY1(E)	RXYQ8PAY1(E) RXYQ8PAY1(E) RXYQ8PAY1(E)	RXYQ8PAY1(E) RXYQ8PAY1(E) RXYQ10PAY1(E)	RXYQ8PAY1(E) RXYQ8PAY1(E) RXYQ12PAY1(E)	RXYQ8PAY1(E) RXYQ10PAY1(E) RXYQ12PAY1(E)	RXYQ8PAY1(E) RXYQ10PAY1(E) RXYQ12PAY1(E)	RXYQ8PAY1(E) RXYQ12PAY1(E) RXYQ12PAY1(E)
Power supply		3-phase 4-wire system, 380-415 V, 50 Hz							
Cooling capacity(*1)(*2)	kcal/h (*1)	38,800	43,600	58,100	63,000	67,800	72,600	77,300	
	Btu/h (*1)	154,000	173,000	231,000	250,000	269,000	288,000	307,000	
	kW (*1)	45.1	50.7	67.6	73.2	78.8	84.4	89.9	
	kW (*2)	44.8	50.4	67.2	72.8	78.3	83.9	89.4	
Heating capacity	kcal/h	43,000	48,600	64,500	70,100	75,300	80,800	86,000	
	Btu/h	171,000	193,000	260,000	278,000	299,000	321,000	341,000	
	kW	50.0	56.5	75.0	81.5	87.5	94.0	100	
Power consumption	Cooling(*2)	10.5	13.1	15.7	18.4	19.4	22.1	23.1	
	Heating	11.5	13.4	17.2	19.2	20.5	22.5	23.9	
Capacity control	%	10-100	8-100	7-100	6-100	6-100	5-100	5-100	
Casing colour		Without (E): Ivory white (5Y7.5/1), With (E): Light camel (2.5Y6.5/1.5)							
Compressor	Type	Hermetically sealed scroll type							
	Motor output	kW	(4.5×1)+(4.5×1)	(4.5×1)+((1.4+4.5)×1)	(4.5×1)+(4.5×1)+ (4.5×1)	(4.5×1)+(4.5×1)+ ((1.4+4.5)×1)	(4.5×1)+(4.5×1)+ ((2.5+4.5)×1)	(4.5×1)+((1.4+4.5)×1)+ ((2.5+4.5)×1)	(4.5×1)+(2.5+4.5)×1)+ ((2.5+4.5)×1)
Airflow rate	ℓ/s	3,000+3,000	3,000+3,083	3,000+3,000+3,000	3,000+3,000+3,083	3,000+3,000+3,883	3,000+3,083+3,883	3,000+3,883+3,883	
	m ³ /min	180+180	180+185	180+180+180	180+180+185	180+180+233	180+185+233	180+233+233	
Dimensions(H×W×D)	mm	(1,680×930×765)+(1,680×930×765)		(1,680×930×765)+(1,680×930×765)+ (1,680×930×765)		(1,680×930×765)+(1,680×930×765)+ (1,680×1,240×765)		(1,680×930×765)+ (1,680×1,240×765)+ (1,680×1,240×765)	
Machine weight	kg	205+205	205+249	205+205+205	205+205+249	205+205+285	205+249+285	205+285+285	
Sound level	dB(A)	60	61	62	62	63	63	64	
Sound power	dB(A)	81	81	83	83	83	83	85	
Operation range	Cooling	°CDB -5 to 43							
	Heating	°CWB -20 to 15.5							
Refrigerant	Type	R-410A							
	Charge	kg	7.2+7.2	7.2+7.9	7.2+7.2+7.2	7.2+7.2+7.9	7.2+7.2+9.5	7.2+7.9+9.5	7.2+9.5+9.5
Piping connections	Liquid	mm	φ12.7 (Brazing)	φ15.9 (Brazing)	φ15.9 (Brazing)	φ19.1 (Brazing)	19.1 (Brazing)	φ19.1 (Brazing)	φ19.1 (Brazing)
	Gas	mm	φ28.6 (Brazing)	φ28.6 (Brazing)	φ34.9 (Brazing)	φ34.9 (Brazing)	34.9 (Brazing)	φ34.9 (Brazing)	φ34.9 (Brazing)

MODEL	Combination units	RXYQ34PAHY1(E)	RXYQ36PAHY1(E)	RXYQ38PAHY1(E)	RXYQ40PAHY1(E)	RXYQ42PAHY1(E)	RXYQ44PAHY1(E)	
		RXYQ10PAY1(E) RXYQ12PAY1(E) RXYQ12PAY1(E)	RXYQ12PAY1(E) RXYQ12PAY1(E) RXYQ12PAY1(E)	RXYQ12PAY1(E) RXYQ12PAY1(E) RXYQ14PAY1(E)	RXYQ12PAY1(E) RXYQ12PAY1(E) RXYQ16PAY1(E)	RXYQ12PAY1(E) RXYQ12PAY1(E) RXYQ18PAY1(E)	RXYQ12PAY1(E) RXYQ12PAY1(E) RXYQ16PAY1(E)	RXYQ12PAY1(E) RXYQ16PAY1(E) RXYQ16PAY1(E)
Power supply		3-phase 4-wire system, 380-415 V, 50 Hz						
Cooling capacity(*1)(*2)	kcal/h (*1)	82,200	87,700	92,900	97,200	101,000	108,000	
	Btu/h (*1)	326,000	348,000	368,000	386,000	399,000	427,000	
	kW (*1)	95.6	102	108	113	117	125	
	kW (*2)	95.0	101	107	112	116	124	
Heating capacity	kcal/h	92,000	97,200	103,000	108,000	114,000	119,000	
	Btu/h	365,000	386,000	409,000	427,000	450,000	471,000	
	kW	107	113	120	125	132	138	
Power consumption	Cooling(*2)	25.8	26.8	30.3	32.1	34.3	37.3	
	Heating	25.8	27.2	29.4	31.0	33.4	34.9	
Capacity control	%	5-100	5-100	4-100	4-100	4-100	4-100	
Casing colour		Without (E): Ivory white (5Y7.5/1), With (E): Light camel (2.5Y6.5/1.5)						
Compressor	Type	Hermetically sealed scroll type						
	Motor output	kW	((1.4+4.5)×1)+((2.5+4.5)×1)+ ((2.5+4.5)×1)	((2.5+4.5)×1)+((2.5+4.5)×1)+ ((2.5+4.5)×1)	((2.5+4.5)×1)+((2.5+4.5)×1)+ ((1.6+4.5+4.5)×1)	((2.5+4.5)×1)+((2.5+4.5)×1)+ ((2.7+4.5+4.5)×1)	((2.5+4.5)×1)+((2.5+4.5)×1)+ ((4.3+4.5+4.5)×1)	((2.5+4.5)×1)+((2.7+4.5+4.5)×1)+ ((2.7+4.5+4.5)×1)
Airflow rate	ℓ/s	3,083+3,883+3,883	3,883+3,883+3,883	3,883+3,883+3,883	3,883+3,883+3,883	3,883+3,883+3,983	3,883+3,883+3,883	
	m ³ /min	185+233+233	233+233+233	233+233+233	233+233+233	233+233+239	233+233+233	
Dimensions(H×W×D)	mm	(1,680×930×765)+ (1,680×1,240×765)+ (1,680×1,240×765)		(1,680×1,240×765)+(1,680×1,240×765)+(1,680×1,240×765)				
Machine weight	kg	249+285+285	285+285+285	285+285+329	285+285+329	285+285+341	285+329+329	
Sound level	dB(A)	64	65	65	65	66	65	
Sound power	dB(A)	85	85	85	85	86	85	
Operation range	Cooling	°CDB -5 to 43						
	Heating	°CWB -20 to 15.5						
Refrigerant	Type	R-410A						
	Charge	kg	7.9+9.5+9.5	9.5+9.5+9.5	9.5+9.5+11.3	9.5+9.5+11.5	9.5+9.5+11.7	9.5+11.5+11.5
Piping connections	Liquid	mm	φ19.1 (Brazing)	φ19.1 (Brazing)	φ19.1 (Brazing)	φ19.1 (Brazing)	φ19.1 (Brazing)	φ19.1 (Brazing)
	Gas	mm	φ34.9 (Brazing)	φ41.3 (Brazing)	φ41.3 (Brazing)	φ41.3 (Brazing)	φ41.3 (Brazing)	φ41.3 (Brazing)

Note: 1. Models with (E) feature components treated for heat and rust corrosion resistance, such as external panels, fan motor, and electric component box, in addition to the fins of the heat exchanger. These models are designed specifically for use in areas which are subject to salt damage and atmospheric pollution. Please contact Daikin for more information.

2. Specifications are based on the following conditions;

•Cooling: (*1) Indoor temp.: 27°CDB, 19.5°CWB, Outdoor temp.: 35°CDB, Equivalent piping length: 7.5 m, Level difference: 0 m.
(*2) Indoor temp.: 27°CDB, 19°CWB, Outdoor temp.: 35°CDB, Equivalent piping length: 7.5 m, Level difference: 0 m.

•Heating: Indoor temp.: 20°CDB, Outdoor temp.: 7°CDB, 6°CWB, Equivalent piping length: 7.5 m, Level difference: 0 m.

•Sound level: Anechoic chamber conversion value, measured at a point 1 m in front of the unit at a height of 1.5 m.

During actual operation, these values are normally somewhat higher as a result of ambient conditions.

High Efficiency Model (Energy Saving Type)

MODEL	Combination units	RX YQ46PAHY1(E)		RX YQ48PAHY1(E)		RX YQ50PAHY1(E)	
		RX YQ12PAY1(E)	RX YQ16PAY1(E)	RX YQ16PAY1(E)	RX YQ16PAY1(E)	RX YQ16PAY1(E)	RX YQ18PAY1(E)
Power supply		3-phase 4-wire system, 380–415 V, 50 Hz					
Cooling capacity(*1)(*2)	kcal/h (*1)	111,000		117,000		120,000	
		440,000		464,000		478,000	
	kW	129		136		140	
		128		135		139	
Heating capacity	kcal/h	124,000		129,000		134,000	
	Btu/h	491,000		512,000		532,000	
	kW	144		150		156	
Power consumption	Cooling(*2)	39.5		42.6		44.8	
	Heating	37.3		38.7		41.1	
Capacity control	%	3-100		3-100		3-100	
Casing colour		Without (E): Ivory white (5Y7.5/1), With (E): Light camel (2.5Y6.5/1.5)					
Compressor	Type	Hermetically sealed scroll type					
	Motor output	kW	$((2.5+4.5) \times 1) + ((2.7+4.5+4.5) \times 1) + ((4.3+4.5+4.5) \times 1)$		$((2.7+4.5+4.5) \times 1) + ((2.7+4.5+4.5) \times 1) + ((2.7+4.5+4.5) \times 1)$		$((2.7+4.5+4.5) \times 1) + ((2.7+4.5+4.5) \times 1) + ((4.3+4.5+4.5) \times 1)$
Airflow rate	ℓ/s	3,883+3,883+3,983		3,883+3,883+3,883		3,883+3,883+3,983	
	m ³ /min	233+233+239		233+233+233		233+233+239	
Dimensions(H×W×D)	mm	(1,680×1,240×765)+(1,680×1,240×765)+(1,680×1,240×765)					
Machine weight	kg	285+329+341		329+329+329		329+329+341	
Sound level	dB(A)	66		65		66	
Sound power	dB(A)	86		85		86	
Operation range	Cooling	°CDB		-5 to 43			
	Heating	°CWB		-20 to 15.5			
Refrigerant	Type	R-410A					
	Charge	kg	9.5+11.5+11.7		11.5+11.5+11.5		11.5+11.5+11.7
Piping connections	Liquid	mm		φ 19.1 (Brazing)		φ 19.1 (Brazing)	
	Gas	mm		φ 41.3 (Brazing)		φ 41.3 (Brazing)	

Note: 1. Models with (E) feature components treated for heat and rust corrosion resistance, such as external panels, fan motor, and electric component box, in addition to the fins of the heat exchanger. These models are designed specifically for use in areas which are subject to salt damage and atmospheric pollution. Please contact Daikin for more information.

2. Specifications are based on the following conditions:

- Cooling: (*1) Indoor temp.: 27°CDB, 19.5°CWB, Outdoor temp.: 35°CDB, Equivalent piping length: 7.5 m, Level difference: 0 m.
(*2) Indoor temp.: 27°CDB, 19°CWB, Outdoor temp.: 35°CDB, Equivalent piping length: 7.5 m, Level difference: 0 m.
- Heating: Indoor temp.: 20°CDB, Outdoor temp.: 7°CDB, 6°CWB, Equivalent piping length: 7.5 m, Level difference: 0 m.
- Sound level: Anechoic chamber conversion value, measured at a point 1 m in front of the unit at a height of 1.5 m.
During actual operation, these values are normally somewhat higher as a result of ambient conditions.

INDOOR UNITS

Ceiling Mounted Cassette (Round Flow) Type

No.	Item	Type	FXFQ25P	FXFQ32P	FXFQ40P	FXFQ50P	FXFQ63P	FXFQ80P	FXFQ100P	FXFQ125P	
1	Decoration panel		BYCP125K-W1								
2	Sealing member of air discharge outlet		KDBH55K160F								
3	Panel spacer		KDBP55H160FA								
4	Filter related	High efficiency filter unit 65%	KAFP556B80						KAFP556B160		
		High efficiency filter unit 90%	KAFP557B80						KAFP557B160		
		Replacement high efficiency filter 65%	KAFP552B80						KAFP552B160		
		Replacement high efficiency filter 90%	KAFP553B80						KAFP553B160		
		Filter chamber	KDDFP55B160								
		Long life replacement filter Non-woven type	KAFP551K160								
		Ultra long-life filter	KAFP55B160								
5	Fresh air intake kit	Chamber type	Without T shape and fan		KDDP55B160						
			With T shape without fan		KDDP55B160K						
		Direct installation type	KDDP55X160								
			KDDP55K160								
6	Branch duct chamber	KDJP55B80							KDJP55B160		
7	Chamber connection kit	KKSJ55KA160									
8	Insulation kit for high humidity	KDTP55K80							KDTP55K160		

Ceiling Mounted Cassette (Compact Multi Flow) Type

No.	Item	Type	FXZQ20M	FXZQ25M	FXZQ32M	FXZQ40M	FXZQ50M
1	Decoration panel		BYFQ60B8W1				
2	Sealing member of air discharge outlet		KDBH44BA60				
3	Panel spacer		KDBQ44BA60A				
4	Replacement long-life filter		KAFQ441BA60				
5	Fresh air intake kit	Direct installation type	KDDQ44XA60				

Ceiling Mounted Cassette (Double Flow) Type

No.	Item	Type	FXCQ20M FXCQ25M FXCQ32M	FXCQ40M	FXCQ50M	FXCQ63M	FXCQ80M	FXCQ125M
1	Decoration Panel		BYBC32G-W1	BYBC50G-W1		BYBC63G-W1	BYBC125G-W1	
2	Filter related	High efficiency filter 65% *1	KAFJ532G36	KAFJ532G56	KAFJ532G80	KAFJ532G160		
		High efficiency filter 90% *1	KAFJ533G36	KAFJ533G56	KAFJ533G80	KAFJ533G160		
		Filter chamber bottom suction	KDDFJ53G36	KDDFJ53G56	KDDFJ53G80	KDDFJ53G160		
		Long life replacement filter	KAFJ531G36	KAFJ531G56	KAFJ531G80	KAFJ531G160		

Note: *1 Filter chamber is required if installing high efficiency filter.

Ceiling Mounted Cassette Corner Type

No.	Item	Type	FXKQ25MA	FXKQ32MA	FXKQ40MA	FXKQ63MA
1	Panel related	Decoration panel	BYK45FJW1			BYK71FJW1
		Panel spacer	KPBJ52F56W			KPBJ52F80W
2	Air inlet and air discharge outlet related	Long life replacement filter	KAFJ521F56			KAFJ521F80
		Air discharge grille	K-HV7AW			K-HV9AW
		Air discharge blind panel	KDBJ52F56W			KDBJ52F80W
		Flexible duct (with shutter)	KFDJ52FA56			KFDJ52FA80

Slim Ceiling Mounted Duct Type (700 mm width type)

No.	Item	Type	FXDQ20PB	FXDQ25PB	FXDQ32PB
1	Insulation kit for high humidity		KDT25N32		

INDOOR UNITS

Slim Ceiling Mounted Duct Type (900/1,100 mm width type)

No.	Item	Type	FXDQ40NB	FXDQ50NB	FXDQ63NB
1	Insulation kit for high humidity		KDT25N50		KDT25N63

Ceiling Mounted Built-in Type

No.	Item	Type	FXSYQ20M FXSYQ25M FXSYQ32M	FXSYQ40M FXSYQ50M	FXSYQ63M	FXSYQ80M FXSYQ100M FXSYQ125M
1	Panel related	Decoration panel	BYBS32DJW1	BYBS45DJW1	BYBS71DJW1	BYBS125DJW1
		Access panel	KTBJ25K36W	KTBJ25KA56W	KTBJ25KA80W	KTBJ25KA160W
2	Filter related	High efficiency filter 65% *1	KAFJ252L36	KAF252LA56	KAF252LA80	KAF252LA160
		High efficiency filter 90% *1	KAFJ253L36	KAF253LA56	KAF253LA80	KAF253LA160
		Long life replacement filter	KAFJ251K36	KAFJ251K56	KAFJ251K80	KAFJ251K160
3	Air inlet related	Filter chamber for bottom suction	KAJ25L36D	KAJ25LA56D	KAJ25LA80D	KAJ25LA160D
		Air suction canvas	KSA-25K36	KSA-25KA56	KSA-25KA80	KSA-25KA160
		Screening door	KBBJ25K36	KBBJ25KA56	KBBJ25KA80	KBBJ25KA160

Note: *1 If installing a high efficiency filter in the Ceiling Mounted Built-in type, a filter chamber for bottom suction is required.

Ceiling Concealed (Duct) Type

No.	Item	Type	FXDYQ80MA	FXDYQ100MA	FXDYQ125MA	FXDYQ145MA	FXDYQ180M	FXDYQ200M	FXDYQ250M
1	Run/fault status PCB		KRP1B5X						

Ceiling Mounted Duct Type

No.	Item	Type	FXMQ20P FXMQ25P FXMQ32P	FXMQ40P	FXMQ50P FXMQ63P FXMQ80P	FXMQ100P FXMQ125P FXMQ140P	FXMQ200MA FXMQ250MA
1	Drain pump kit		—				KDU30L250VE
2	High efficiency filter	65%	KAF372AA36	KAF372AA56	KAF372AA80	KAF372AA160	KAFJ372L280
		90%	KAF373AA36	KAF373AA56	KAF373AA80	KAF373AA160	KAFJ373L280
3	Filter chamber		KDDF37AA36	KDDF37AA56	KDDF37AA80	KDDF37AA160	KDJ3705L280
4	Long life replacement filter		KAF371AA36	KAF371AA56	KAF371AA80	KAF371AA160	KAFJ371L280
5	Long life filter chamber kit		KAF375AA36	KAF375AA56	KAF375AA80	KAF375AA160	—
6	Service panel	White	KTBJ25K36W	KTBJ25KA56W	KTBJ25KA80W	KTBJ25KA160W	
		Fresh white	KTBJ25K36F	KTBJ25K56F	KTBJ25K80F	KTBJ25K160F	
		Brown	KTBJ25K36T	KTBJ25K56T	KTBJ25K80T	KTBJ25K160T	
7	Air discharge adaptor		KDAJ25K36A	KDAJ25K56A	KDAJ25K71A	KDAJ25K140A	

INDOOR UNITS

Ceiling Suspended Type

No.	Item	Type	FXHQ32MA	FXHQ63MA	FXHQ100MA
1	Drain pump kit		KDU50N60VE	KDU50N125VE	
2	Replacement long-life filter (Resin net)		KAF501DA56	KAF501DA80	KAF501DA112
3	L-type piping kit (for upward direction)		KHFP5MA63		

Wall Mounted Type

No.	Item	Type	FXAQ20P	FXAQ25P	FXAQ32P	FXAQ40P	FXAQ50P	FXAQ63P
1	Drain pump kit		K-KDU572EVE					

Floor Standing Type

No.	Item	Type	FXLQ20MA	FXLQ25MA	FXLQ32MA	FXLQ40MA	FXLQ50MA	FXLQ63MA
1	Long life replacement filter		KAFJ361K28		KAFJ361K45		KAFJ361K71	

Concealed Floor Standing Type

No.	Item	Type	FXNQ20MA	FXNQ25MA	FXNQ32MA	FXNQ40MA	FXNQ50MA	FXNQ63MA
1	Long life replacement filter		KAFJ361K28		KAFJ361K45		KAFJ361K71	

Ceiling Suspended Cassette Type

No.	Item	Type	FXUQ71MA	FXUQ100MA	FXUQ125MA
1	Replacement long-life filter		KAF495FA140		
2	Sealing member of air discharge outlet (*1)		KDBH49FA80	KDBH49FA140	
3	Decoration panel for air discharge		KDBT49FA80	KDBT49FA140	
4	Vertical flap kit		KDGJ49FA80	KDGJ49FA140	
5	L-shape piping kit		KHFP49MA140		

Note: (*1): This option is necessary for setting up 2-way (opposing directional) airflow when the air conditioner is installed.

OUTDOOR UNITS

Standard Model (Space Saving Type)

No.	Type		RX(Y)Q5PA(E)	RXYQ6PA RX(Y)Q8PA(E) RX(Y)Q10PA(E)	RX(Y)Q12PA(E) RX(Y)Q14PA(E) RX(Y)Q16PA(E) RX(Y)Q18PA(E)
	Item				
1	Cool/Heat Selector		KRC19-26A (Applies to RXYQ only)		
1-1	Fixing box		KJB111A (Applies to RXYQ only)		
2	Distributive piping	REFNET header	KHRP26M22H (Max. 4 branch)	KHRP26M22H (Max. 4 branch) KHRP26M33H (Max. 8 branch)	KHRP26M22H (Max. 4 branch), KHRP26M33H (Max. 8 branch) KHRP26M72H (Max. 8 branch)
		REFNET joint	KHRP26A22T	KHRP26A22T, KHRP26A33T	KHRP26A22T, KHRP26A33T, KHRP26A72T
3	Central drain pan kit		KWC26C160(E)	KWC26C280(E)	KWC26C450(E)
4	Digital pressure gauge kit		BHGP26A1(E)		

No.	Type		RX(Y)Q20PA(E) RX(Y)Q22PA(E)	RX(Y)Q24PA(E) RX(Y)Q26PA(E) RX(Y)Q28PA(E)	RX(Y)Q30PA(E) RX(Y)Q32PA(E) RX(Y)Q34PA(E) RX(Y)Q36PA(E)	RX(Y)Q38PA(E) RX(Y)Q40PA(E) RX(Y)Q42PA(E) RX(Y)Q44PA(E) RX(Y)Q46PA(E)	RX(Y)Q48PA(E) RX(Y)Q50PA(E) RX(Y)Q52PA(E) RX(Y)Q54PA(E)
	Item						
1	Cool/Heat Selector		KRC19-26A (Applies to RXYQ only)				
1-1	Fixing box		KJB111A (Applies to RXYQ only)				
2	Distributive piping	REFNET header	KHRP26M22H (Max. 4 branch) KHRP26M33H (Max. 8 branch) KHRP26M72H (Max. 8 branch)	KHRP26M22H (Max. 4 branch), KHRP26M33H (Max. 8 branch) KHRP26M72H (Max. 8 branch), KHRP26M73H (Max. 8 branch)			
		REFNET joint	KHRP26A22T, KHRP26A33T KHRP26A72T	KHRP26A22T, KHRP26A33T, KHRP26A72T, KHRP26A73T			
3	Pipe size reducer		—	KHRP26M73TP, KHRP26M73HP			
4	Outdoor unit multi connection piping kit		BHFP22P100			BHFP22P151	
5	Central drain pan kit		KWC26C280(E) KWC26C450(E)	KWC26C450(E)×2	KWC26C280(E) KWC26C450(E)×2	KWC26C450(E)×3	
6	Digital pressure gauge kit		BHGP26A1(E)				

(E): Specification with anti-corrosion treatment for the heat pump type only.

High Efficiency Model (Energy Saving Type)

No.	Type		RX(Y)Q16PAH(E) RX(Y)Q18PAH(E)	RX(Y)Q24PAH(E) RX(Y)Q26PAH(E)	RX(Y)Q28PAH(E) RX(Y)Q30PAH(E)	RX(Y)Q32PAH(E) RX(Y)Q34PAH(E)	RX(Y)Q36PAH(E) RX(Y)Q38PAH(E) RX(Y)Q40PAH(E) RX(Y)Q42PAH(E) RX(Y)Q44PAH(E) RX(Y)Q46PAH(E) RX(Y)Q48PAH(E) RX(Y)Q50PAH(E)
	Item						
1	Cool/Heat Selector		KRC19-26A (Applies to RXYQ only)				
1-1	Fixing box		KJB111A (Applies to RXYQ only)				
2	Distributive piping	REFNET header	KHRP26M22H (Max. 4 branch) KHRP26M33H (Max. 8 branch) KHRP26M72H (Max. 8 branch)	KHRP26M22H (Max. 4 branch), KHRP26M33H (Max. 8 branch) KHRP26M72H (Max. 8 branch), KHRP26M73H (Max. 8 branch)			
		REFNET joint	KHRP26A22T, KHRP26A33T KHRP26A72T	KHRP26A22T, KHRP26A33T, KHRP26A72T, KHRP26A73T			
3	Pipe size reducer		—	KHRP26M73TP, KHRP26M73HP			
4	Outdoor unit multi connection piping kit		BHFP22P100		BHFP22P151		
5	Central drain pan kit		KWC26C280(E)×2	KWC26C280(E)×3	KWC26C280(E)×2 KWC26C450(E)	KWC26C280(E) KWC26C450(E)×2	KWC26C450(E)×3
6	Digital pressure gauge kit		BHGP26A1(E)				

(E): Specification with anti-corrosion treatment for the heat pump type only.

Individual Control Systems

Wired remote controller (Option)



BRC1C62

- Digital display lets you set temperature in 1°C units.
- Lets you individually programme by timer the respective times for operation start and stop within a maximum of 72 hours.
- Equipped with a thermostat sensor in the remote controller that makes possible more comfortable room temperature control.
- Enables you to select cool/heat/fan operation mode with the indoor remote controller of your choice without using the cool/heat selector. (dependant on system)
- Equipped with self-diagnosis function that constantly monitors the system for malfunctions. Should a problem occur, the system alerts you of the problem through an alphanumeric code.
- Enables you to select the ventilation mode and the volume of the Heat Reclaim Ventilator (when connected to a VAM).
- The rubber switch and the oil-resisting resin casing have been adopted for durability.

* When the auto-swing function is not available, the message, THIS FUNCTION IS NOT AVAILABLE is displayed when the air direction adjustment button is pressed.

Wired remote controller with weekly schedule timer (Option)



BRC1D61

Adds advanced functions to those of the above wired remote controller.

- Includes ventilation mode and airflow rate switching, the main functions of Heat Reclaim Ventilator series.
- 24-hour clock function (1-hour backup for power failures)
- Programming function for each day of week.
- Scheduling possible of start/stop and temperature limit (5 settings/day)
- Programming can be enabled or disabled.
- Copy function for programmed schedules.

Notes: 1. Standard remote controllers (BRC1C62) not required.
2. If the BRC1D61 is connected to the centralised remote controllers (DCS303A51, DCS302CA61, DCS301BA61, DST301BA61), the schedule function is not available.

The wired remote controller supports a wide range of control functions

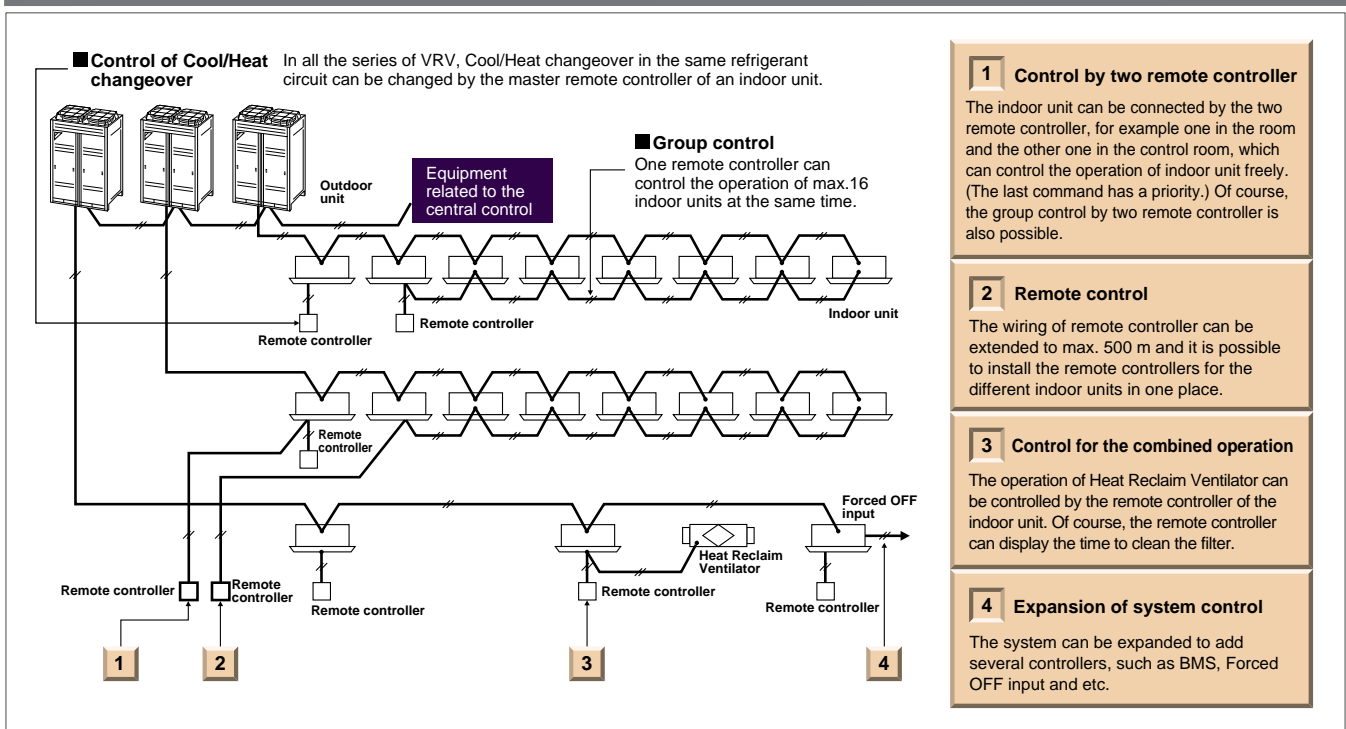

Wireless remote controller (Option)



Wireless remote controller



Signal receiver unit (Separate type)

- The same operation modes and settings as with wired remote controllers are possible.
- A compact signal receiver unit (separate type) to be mounted into a wall or ceiling is included.
 - A signal receiver unit (installed type) for a Ceiling Mounted Cassette (Round Flow, Compact Multi Flow, Double Flow) type, Ceiling Suspended type and Wall Mounted type is mounted into the indoor unit.

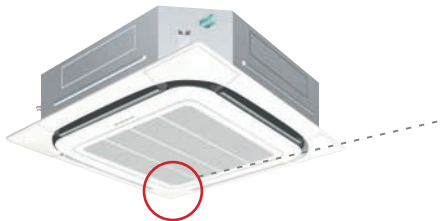

Signal receiver unit can be installed on the panel
ex. Ceiling Mounted Cassette (Round Flow) type

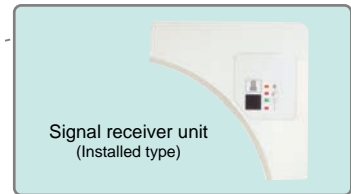

*Wireless remote controller and signal receiver unit are sold as a set.
*Refer to page 59 for the name of each model.

Simplified remote controller (Option)



Exposed type (BRC2C51)



Concealed type (For hotel use) (BRC3A61)

- The remote controller has centralised its frequently used operation selectors and switches (on/off, operation mode, temperature setting and airflow volume), making itself suitable for use in hotel rooms or conference rooms.
- The exposed type remote controller is fitted with a thermostat sensor.



The concealed type remote controller smartly fits into a night table or console panel in a hotel room.

Wide variation of remote controllers for indoor units

	FXFQ	FXZQ	FXCQ	FXKQ	FXDQ	FXSYQ	FXDYQ	FXMQ	FXHQ	FXAQ	FXL(N)Q	FXUQ
Wired remote controller (BRC1C62)	●	●	●	●	●	●	●	●	●	●	●	●
Wired remote controller with weekly schedule timer (BRC1D61)	●	●	●	●	●	●	●	●	●	●	●	●
Wireless remote controller* (Installed type signal receiver unit)	●	●	●						●	●		●
Wireless remote controller* (Separate type signal receiver unit)				●	●	●	●	●			●	
Simplified remote controller (Exposed type) (BRC2C51)					●	●	●	●			●	
Simplified remote controller (Concealed type: for Hotel use) (BRC3A61)					●	●	●	●			●	

*Refer to page 59 for the name of each model.

Centralised Control Systems

- Up to 64 groups of indoor units (128 units) can be centrally controlled.
- System integration with various air-conditioning peripheral equipment such as Heat Reclaim Ventilator, is easy.
- Optional controllers for centralised control can be combined and optimised in accordance with building scale and purpose.
- Wiring can be run up to a total length of 2 km, and adapts easily to large-scale system expansion.

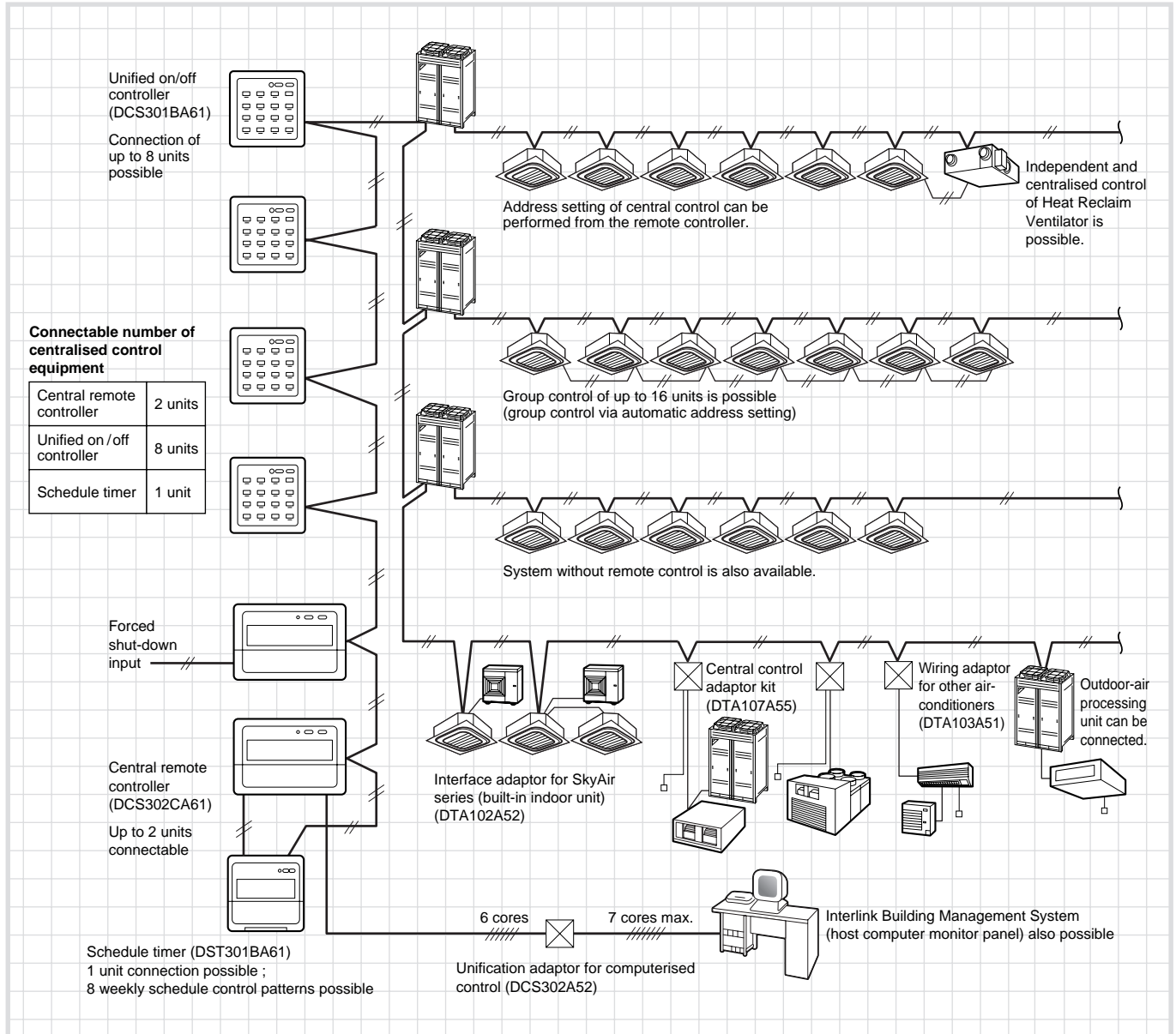

• Certain indoor units limit the functions of some control systems.
For more details, please refer to the Engineering Data Book.

Residential central remote controller* (Option)



DCS303A51

Max. 16 groups of indoor units can be easily controlled with the large LCD panel.

- Max. 16 groups (128 indoor units) controllable
- Backlight and large LCD panel for easy readability
- ON/OFF, temperature settings and scheduling can be controlled individually for indoor units.
- All indoor units can be turned on or off at once with "ALL" button.
- Each group has a dedicated button for convenience.
- Outside temperature display

* For residential use only. Cannot be used with other centralised control equipment.

Central remote controller (Option)

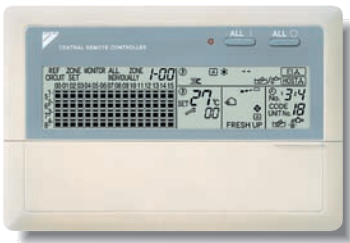

DCS302CA61

Max. 64 groups (zones) of indoor units can be controlled individually same as LCD Remote controller.

- Max. 64 groups (128 indoor units) controllable
- Max. 128 groups (128 indoor units) are controllable by using 2 central remote controllers, which can control from 2 different places.
- Zone control
- Malfunction code display
- Max. wiring length 1,000 m (Total: 2,000 m)
- Connectable with Unified ON/OFF controller, schedule timer and BMS system
- Airflow volume and direction can be controlled individually for indoor units in each group operation.
- Ventilation volume and mode can be controlled for Heat Reclaim Ventilator.
- Up to 4 ON/OFF pairs can be set per day by connecting a schedule timer.

Unified ON/OFF controller (Option)



DCS301BA61

Max. 16 groups of indoor units can be operated simultaneously/individually.

- Max. 16 groups (128 indoor units) controllable
- 2 remote controllers can be used to control from 2 different places.
- Operating status indication (Normal operation, Alarm)
- Centralised control indication
- Max. wiring length 1,000 m (Total: 2,000 m)
- Compact size casing (Thickness: 16 mm)
- Connectable with Central Remote controller, Schedule timer and BMS system

Schedule timer (Option)



DST301BA61

Max. 128 indoor units can be operated as programmed schedule.

- Max. 128 indoor units controllable
- When used in combination with a central remote controller, a maximum of 8 weekly schedule patterns can be set, while the central controller can be used to select desired zones. Up to 2 ON/OFF pairs can be set per day.
- Max. 48 hours back up power supply
- Max. wiring length 1,000 m (Total: 2,000 m)
- Compact size casing (Thickness: 16 mm)
- Connectable with Central Remote controller, Unified ON/OFF controller and BMS system

Advanced Control Systems



One touch selection to total air comfort

Daikin proudly introduces its new *intelligent Touch Manager*, a VRV system controller featuring an array of simple, useful system management functions for added value.

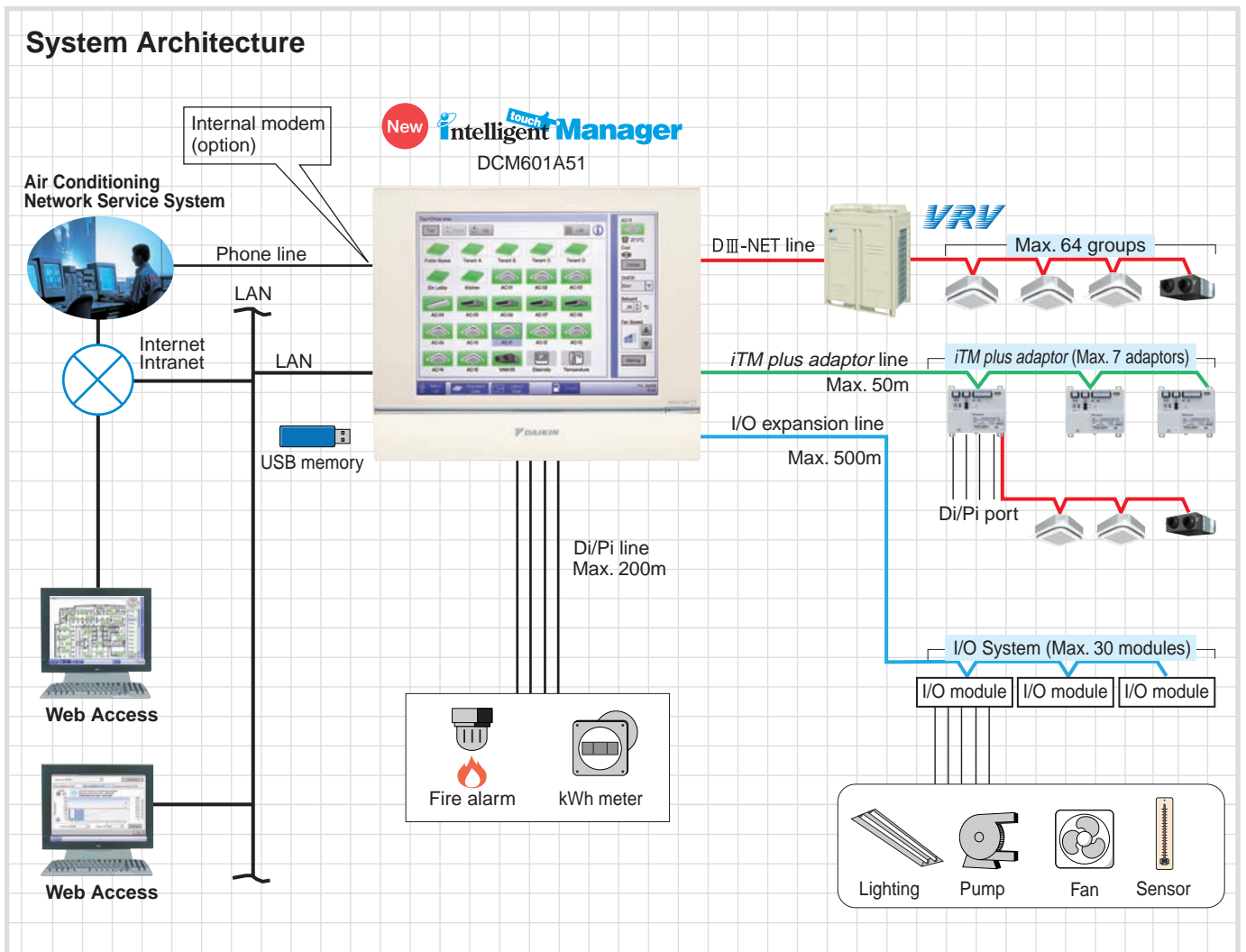



Features

■ Central control

- Handy area settings simplify detailed management of VRV.
- Display of floor plans enables a quick search of desired air conditioning units.
- Operation history shows manner of control and origin in past operations of air conditioning units.

■ Remote access

- Remote access with a PC allows total air conditioning management using the same type of screens as those displayed in the *intelligent Touch Manager*.
- Authorised users can centrally control individual air conditioning units from their own computers.

■ Automatic control

- VRVs are controlled automatically throughout the year by the schedule function.
- Interlocking VRVs and other equipment enables easy automation of building facilities operation.
- Setback adjusts temperature settings even when rooms are unoccupied.

■ Energy management

- The Energy Navigator feature simplifies energy management by tracking energy consumption data and identifying inefficient operation.

■ Troubleshooting

- Contact information of maintenance contractors can be registered and displayed.
- E-mails are sent automatically to alert of malfunctions and potential trouble.
- The *intelligent Touch Manager* can link to the Air Conditioning Network Service System for 24-hour monitoring of operating conditions and status.

■ Scalability

- A single *intelligent Touch Manager* can manage a small building or be expanded to handle medium- to large-sized buildings.
- Large building properties can also take advantage of the *iTM integrator* to link up and expand system up to 5 *intelligent Touch Managers* for integrated control.

Advanced Control Systems

Intelligent touch Controller

Communication functions in the user-friendly icon-based multilingual controller simplify centralised control of the VRV system.

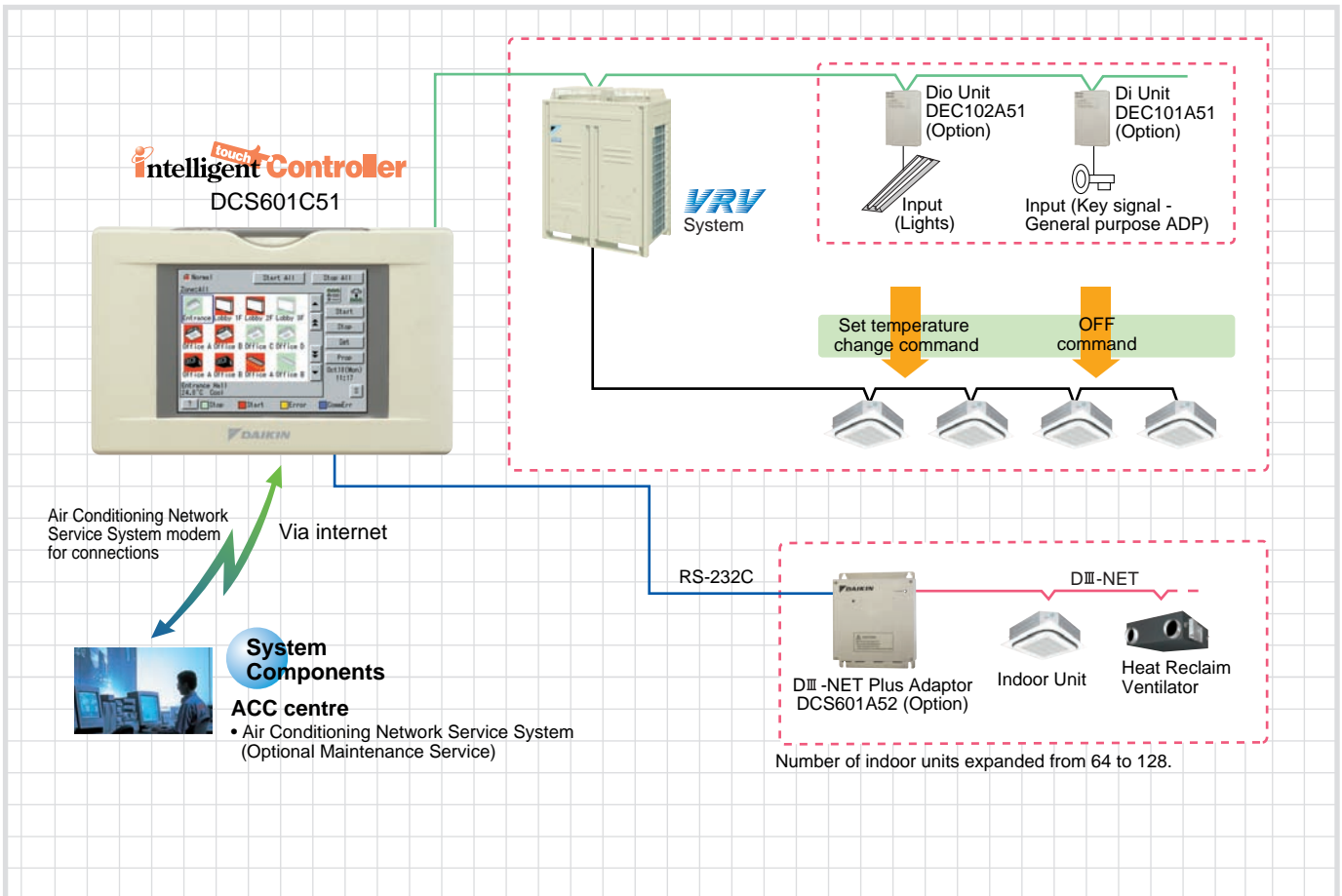

Features

- Colour LCD touch panel icon display
- Small manageable size
- Simplified engineering
- Multi language (English, French, Italian, German, Spanish, Dutch, Portuguese, Chinese and Korean)
- Yearly schedule
- Auto heat/cool change-over
- Temperature limitation
- Enhanced history function
- Simple Interlock Function
- Built-in modem for connecting to Air Conditioning Network Service System (Option)
- Doubling of number of connectable indoor units by adding a DIII-NET Plus Adaptor (Option)
- Management of facilities/equipment other than A/C units (By adding Dio unit or Di unit)





Interface for BACnet® and LONWORKS®

Integrated control systems that recognise the trend of open control systems

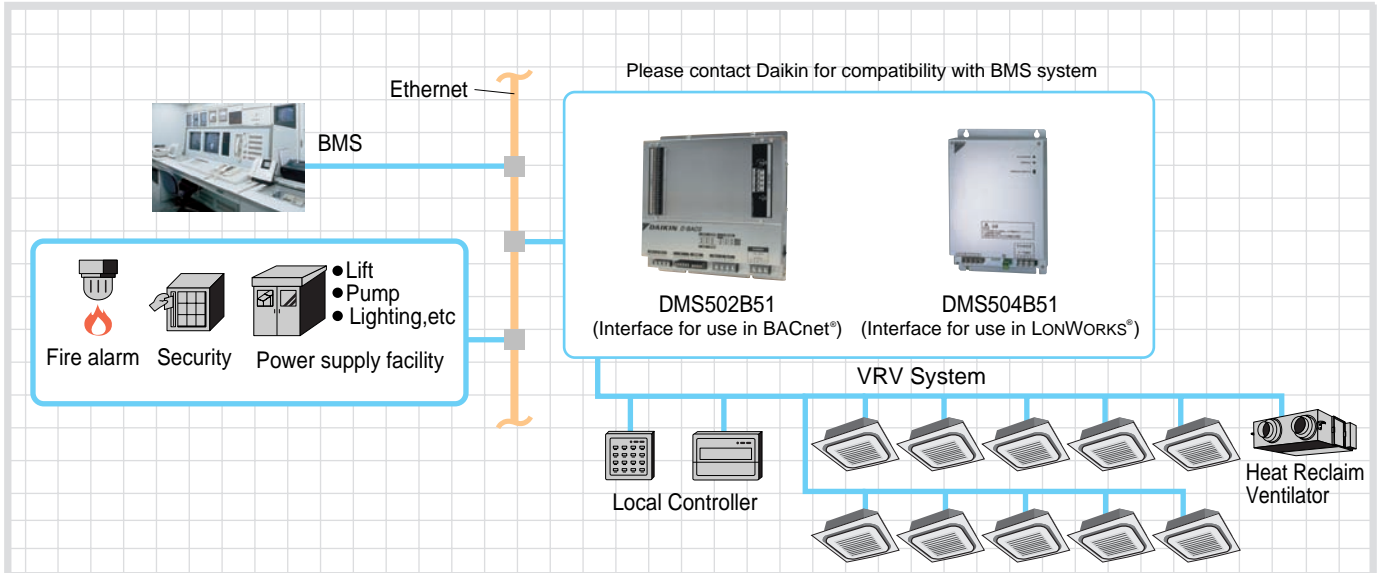

- Compatibility with BMS enhanced by utilising the international communication standards, BACnet® or LONWORKS®.

DMS502B51 Interface for use in BACnet®

- BTL Certification
- PPD data (Optional Di board is required.)
- ISO 16484-5 (Does not support IEEE 802.3 protocol for BACnet®)
- Conformance class 3 (ASHRAE 135–1995)
- Standard BACnet® Device B-ASC (ASHRAE 135–2001)
- Up to 40 outdoor units and 256 indoor unit groups on one gateway (Optional adaptor)

DMS504B51 Interface for use in LONWORKS®

- XIF file for confirming of specifications of the units.
- Connectable up to 10 outdoor units and 64 indoor unit groups.

Air Conditioning Network Service System

Maintenance services that boost profits and customer satisfaction

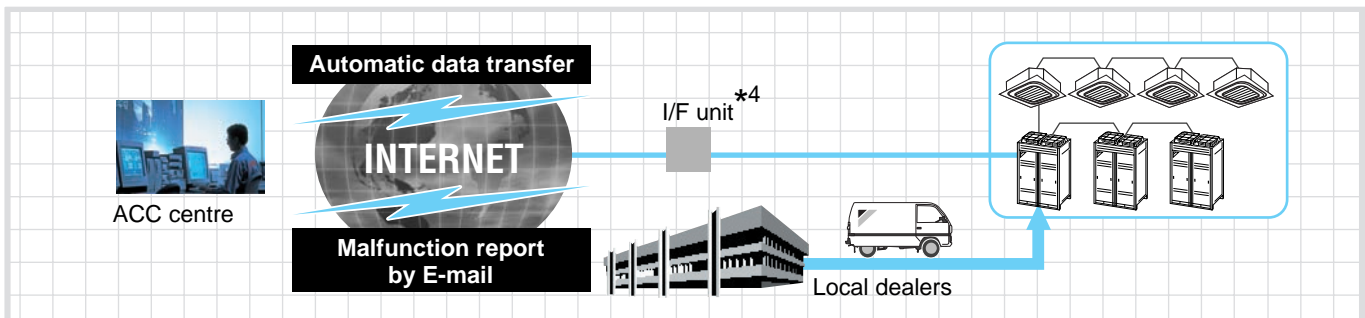

- 24 hour on-line diagnostic system
- Energy saving and extension of aircon operating life
- Maintenance management via A/C network service system reports
- Reliable service at short lead time

*1. Model name varies upon the system size.

*2. BACnet® is a registered trademark of American Society of Heating, Refrigerating and Air-Conditioning Engineers (ASHRAE).

*3. LonWorks® is a trademark of Echelon Corporation registered in the United States and other countries.

*4. For an I/F unit, one of the following can be selected: **Local Controller**, intelligent Touch Controller, or intelligent Touch Manager.

*5. Refer to the Options page for the name of each model.

Integrated Building Monitoring System

The high speed transmission of DIII-NET enables more advanced control of the VRV system, providing you with enhanced comfort.

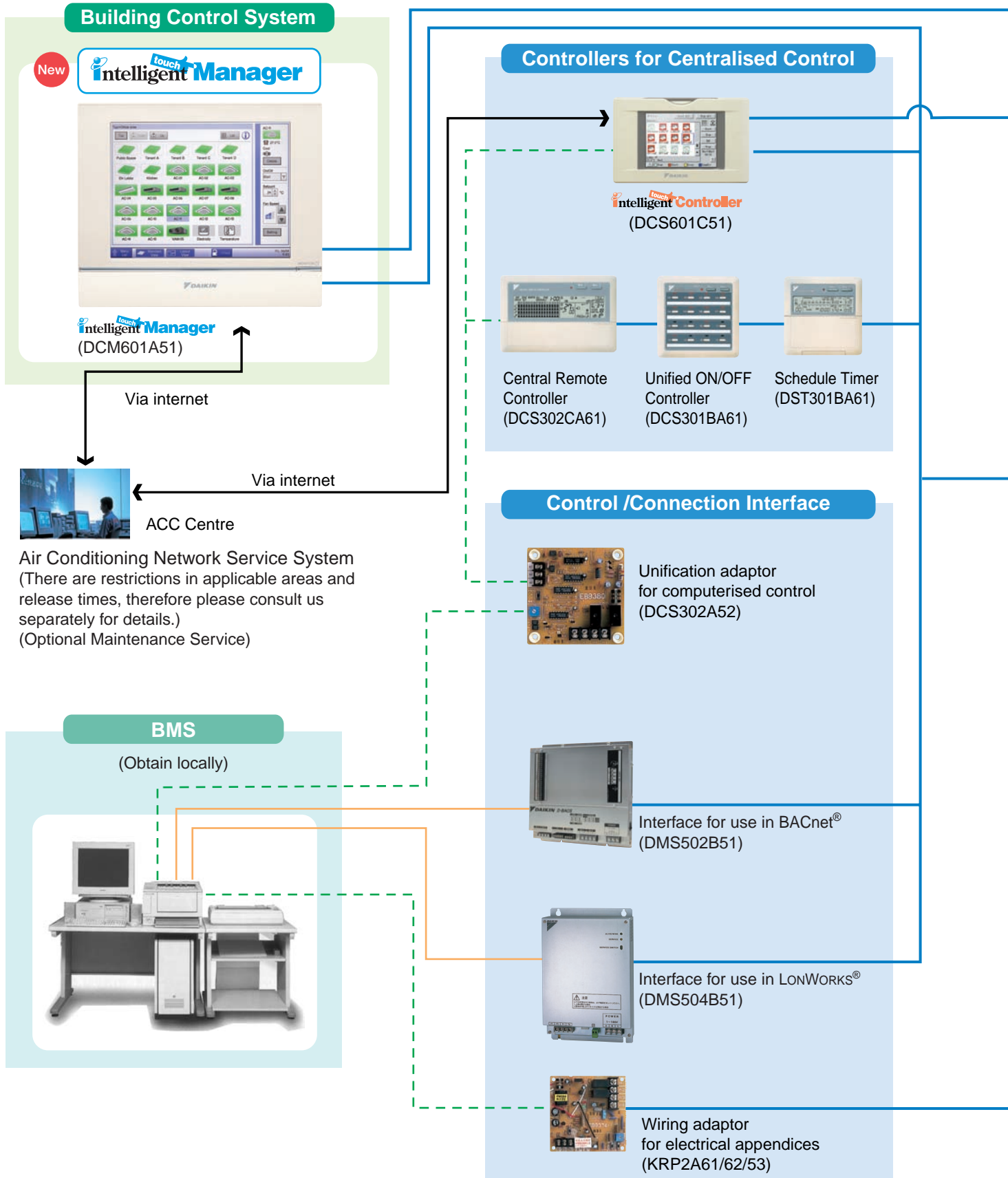

- DIII-NET Line
- BACnet®/Ethernet or LONWORKS® Network Communication Line
- - - Contact Signal Line

The DIII-NET system provides for:

- Close control and monitoring by integrating a wide variety of air-conditioners in the entire building.
- Saving the in-building cabling using non-polar, two-wire cables. Easier wiring work with tremendously fewer wiring errors.
- Additional setups readily up and running. An extendable cabling up to 2 km in total.
- Different control equipment flexibly joined in the system for hierarchical risk diversification.
- Daikin's total heat exchangers and other devices under integral control.

DIII-NET

(High Speed Multiple Transmission)

DIII-NET, Daikin's unique high speed multiple transmission system, links air conditioners and various other building equipment—in accordance with applications, scale and conditions—and transmits vast amounts of information between them.

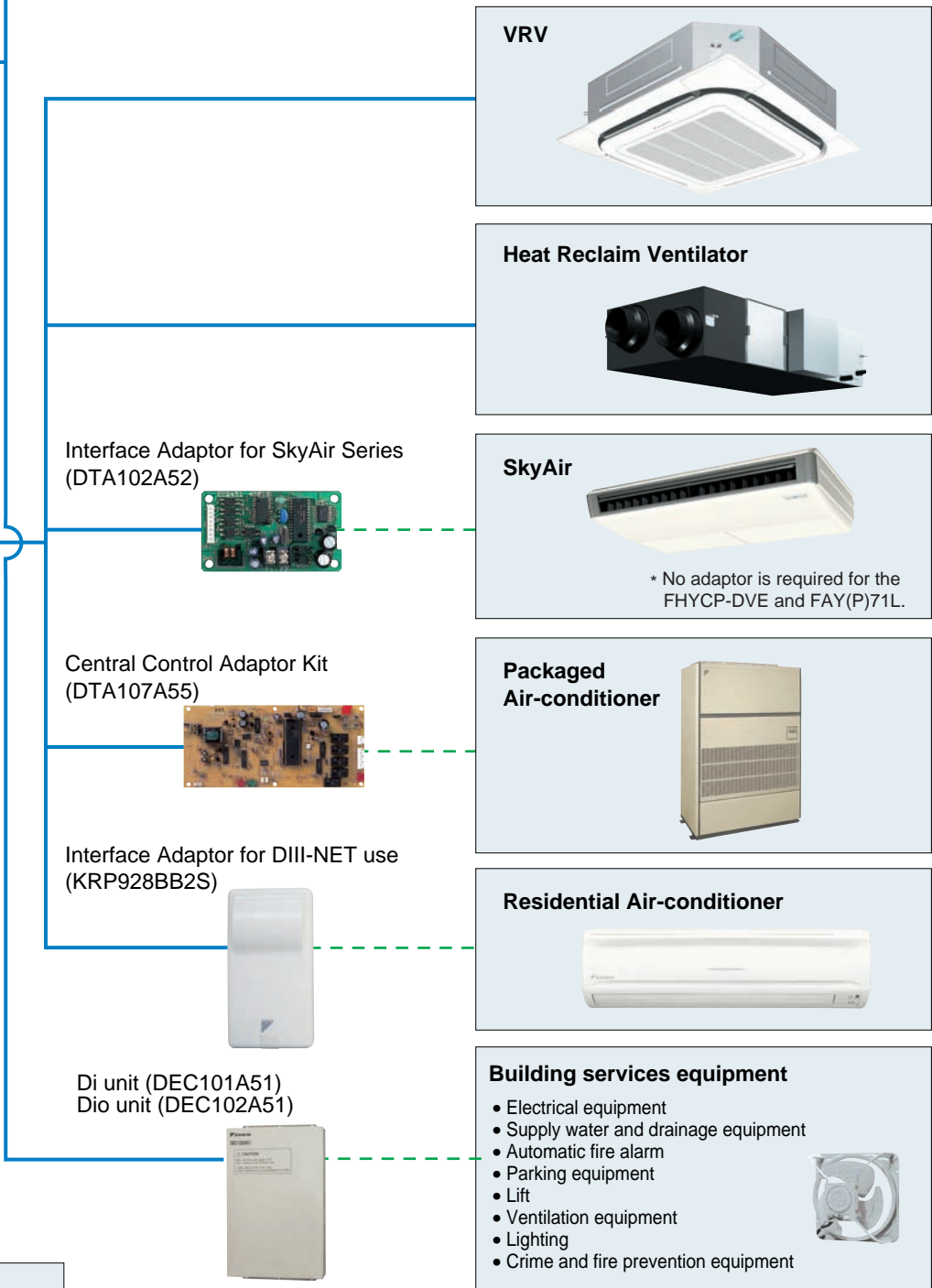

Caution:
Limitation may apply to some models and functions. Please contact your local sales office for details. Consultation is necessary before employing this control system. Please contact your local sales office before making a purchase.

Note: BACnet® is a registered trademark of American Society of Heating, Refrigerating and Air-Conditioning Engineers (ASHRAE). LONWORKS® is a trademark of Echelon Corporation registered in the United States and other countries.

Control Systems—Option List

Operation Control System Optional Accessories

No.	Item	Type		FXFQ-P	FXZQ-M	FXCQ-M	FXKQ-MA	FXDQ-PB FXDQ-NB	FXSYQ-M	FXDYQ-M(A)	FXMQ-P	FXMQ-MA	FXHQ-MA	FXAQ-P	FXLQ-MA FXNQ-MA	FXUQ-MA
		Wireless	C/O H/P													
1	Remote controller	Wireless	C/O	BRC7F635F	BRC7E531W	BRC7C67	BRC4C63	BRC4C66	BRC4C64	BRC4C64	BRC4C66	BRC4C64	BRC7EA66	BRC7EA619	BRC4C64	BRC7CA529W
			H/P	BRC7F634F	BRC7E530W	BRC7C62	BRC4C61	BRC4C65	BRC4C62	BRC4C62	BRC4C65	BRC4C62	BRC4C62	BRC7EA63W	BRC7EA618	BRC4C62
		Wired		BRC1C62												
2	Wired remote controller with weekly schedule timer			BRC1D61												
3	Simplified remote controller (Exposed type)			BRC2C51												
4	Remote controller for hotel use (Concealed type)			BRC3A61												
5	Adaptor for wiring			*KRP1C63	*KRP1BA57	*KRP1B61	KRP1B61	*KRP1B56	KRP1B61		*KRP1C64	KRP1B61	KRP1BA54	—	KRP1B61	—
6-1	Wiring adaptor for electrical appendices (1)			*KRP2A62	*KRP2A62	*KRP2A61	KRP2A61	*KRP2A53	KRP2A61		*KRP2A61	KRP2A61	*KRP2A62	*KRP2A61	KRP2A61	—
6-2	Wiring adaptor for electrical appendices (2)			*KRP4AA53	*KRP4AA53	*KRP4AA51	KRP4AA51	*KRP4A54	KRP4AA51		*KRP4AA51	KRP4AA51	*KRP4AA52	*KRP4AA51	KRP4AA51	*KRP4AA53
7	Remote sensor (for indoor temperature)			KRCS01-4B	KRCS01-1B										KRCS01-4B	KRCS01-1B
8	Installation box for adaptor PCB ☆			Note 2,3 KRP1H98	Note 4,6 KRP1BA101	Note 2,3 KRP1B96	—	Note 4,6 KRP1BA101	Note 5 KRP4A91	—	Note 2,3 KRP4A96	—	Note 3 KRP1CA93	Note 2,3 KRP4A93	—	KRP1BA97
9	External control adaptor for outdoor unit			*DTA104A62	*DTA104A61	DTA104A61	*DTA104A53	DTA104A61		*DTA104A61	DTA104A61	*DTA104A62	*DTA104A61	DTA104A61	—	
10	Adaptor for multi tenant			*DTA114A61	—										*DTA114A61	—

Note: 1. Installation box ☆ is necessary for each adaptor marked *.
2. Up to 2 adaptors can be fixed for each installation box.

3. Only one installation box can be installed for each indoor unit.
4. Up to 2 installation boxes can be installed for each indoor unit.

5. Installation box ☆ is necessary for second adaptor.
6. Installation box ☆ is necessary for each adaptor.

System Configuration

No.	Item	Model No.	Function
1	Residential central remote controller	Note 3 DCS303A51	•Up to 16 groups of indoor units (128 units) can be easily controlled using the large LCD panel. ON/OFF, temperature settings and scheduling can be controlled individually for indoor units.
2	Central remote controller	Note 2 DCS302CA61	•Up to 64 groups of indoor units(128 units) can be connected, and ON/OFF, temperature setting and monitoring can be accomplished individually or simultaneously. Connectable up to 2 controllers in one system.
2-1	Electrical box with earth terminal (3 blocks)	KJB311AA	
3	Unified ON/OFF controller	Note 2 DCS301BA61	•Up to 16 groups of indoor units(128 units) can be turned, ON/OFF individually or simultaneously, and operation and malfunction can be displayed. Can be used in combination with up to 8 controllers.
3-1	Electrical box with earth terminal (2 blocks)	KJB212AA	
3-2	Noise filter (for electromagnetic interface use only)	KEK26-1A	
4	Schedule timer	Note 2 DST301BA61	•Programmed time weekly schedule can be controlled by unified control for up to 64 groups of indoor units (128 units). Can turn units ON/OFF twice per day.
5	Interface adaptor for SkyAir-series	For SkyAir, FD(Y)M-FA, FDY-KA, FDYB-KA, FVY(P)J-A, FXUQ-MA *DTA102A52	•Adaptors required to connect products other than those of the VRV System to the high-speed DIII-NET communication system adopted for the VRV System. * To use any of the above optional controllers, an appropriate adaptor must be installed on the product unit to be controlled.
6	Central control adaptor kit	For UAT(Y)-K(A),FD-K *DTA107A55	
7	Wiring adaptor for other air-conditioner	*DTA103A51	
8	DIII-NET Expander Adaptor	DTA109A51	•Up to 1024 units can be centrally controlled in 64 different groups. •Wiring restrictions (max. length: 1,000m, total wiring length: 2,000m, max. number of branches: 16) apply to each adaptor.
8-1	Mounting plate	KRP4A92	•Fixing plate for DTA109A51

Notes: 1. Installation box for * adaptor must be obtained locally.
2. For FXUQ-MAV1, an interface adaptor (DTA102A52) for the SkyAir series is necessary.
3. For residential use only. Cannot be used with other centralised control equipment.

Building Management System

No.	Item	Model No.	Function
1	intelligent Touch Controller	DCS601C51	•Air-Conditioning management system that can be controlled by a compact all-in-one unit.
1-1		Option Hardware DIII-NET plus adaptor	•Additional 64 groups (10 outdoor units) is possible.
1-2	Electrical box with earth terminal (4 blocks)	KJB411A	•Wall embedded switch box.
2		Basic Hardware intelligent Touch Manager	•Air-conditioning management system that can be controlled by touch screen.
2-1		Option Hardware iTm plus adaptor	•Additional 64 groups (10 outdoor units) is possible. Max. 7 iTm plus adaptors can be connected to intelligent Touch Manager.
2-2		Option Hardware iTm integrator	•Max. 5 intelligent Touch Managers can be integrated.
2-3		Option Software iTm power proportional distribution	•Power consumption of indoor units are calculated based on operation status of the indoor unit and outdoor unit power consumption measured by kWh metre.
2-4		Option Software iTm energy navigator	•Building energy consumption is visualised. Wasted air-conditioning energy can be found out.
2-5	Di unit	DEC101A51	•8 pairs based on a pair of On/Off input and abnormality input.
2-6	Dio unit	DEC102A51	•4 pairs based on a pair of On/Off input and abnormality input.
3		*1 Interface for use in BACnet*	•Interface unit to allow communications between VRV and BMS. Operation and monitoring of air-conditioning systems through BACnet* communication.
3-1	Communication line	Optional DIII board	•Expansion kit, installed on DMS502B51, to provide 2 more DIII-NET communication ports. Not usable independently.
3-2		Optional Di board	•Expansion kit, installed on DMS502B51, to provide 16 more wattmeter pulse input points. Not usable independently.
4		*2 Interface for use in LonWorks*	•Interface unit to allow communications between VRV and BMS. Operation and monitoring of air-conditioning systems through LonWorks* communication.
5	Contact/analogue signal	Unification adaptor for computerised control *DCS302A52	•Interface between the central monitoring board and central control units.

Notes: *1. BACnet* is a registered trademark of American Society of Heating, Refrigerating and Air-Conditioning Engineers (ASHRAE).
2. LonWorks is a trademark of Echelon Corporation registered in the United States and other countries.
*3. Installation box for * adaptor must be obtained locally.

Daikin's air treatment systems creating a higher air quality environment

Components of Indoor Air Quality

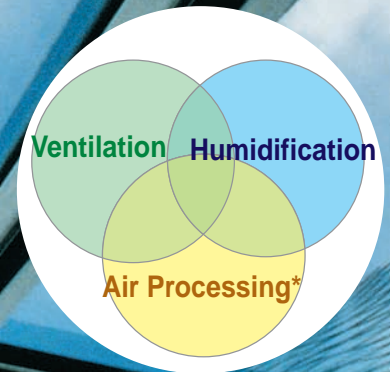

*Refers to bringing outdoor air to near indoor temperature and delivering to a room.

A recent trend rapidly gaining popularity is for air treatment to be required as well as air conditioning. Daikin's Outdoor-Air Processing Unit can combine fresh air treatment and air conditioning, supplied from a single system. It adjusts the temperature of air from outdoors using a fixed discharge temperature control. Along with Outdoor-Air Processing Units, we also offer Heat Reclaim Ventilator systems. The Heat Reclaim Ventilator VAM-GJ series units in particular have been praised for their compactness, energy conservation and extensive operation range of outdoor temperatures. This series provides higher enthalpy efficiency ^{*1}, due to the greatly enhanced performance of the thin film element. Furthermore, improved external static pressure ^{*2} offers more flexibility for installation. The Heat Reclaim Ventilator VKM-GAM series units, equipped with a DX-coil and a humidifier, provide further advanced features, such as temperature adjustment to suit conditions indoors and to prevent cold air from blowing on people directly during heating operation. The series also realises significant energy savings by exercising heat recovery.

^{*1} For models: VAM150/250/350/650/800/1000/2000GJVE
^{*2} For models: VAM150/350/500GJVE

		Outdoor-Air Processing Unit	Heat Reclaim Ventilator			
			VKM-GAM Type*	VKM-GA Type*	VAM-GJ Type*	
Connections with VRVIII	Refrigerant Piping	Connectable	Connectable	Connectable	Not connectable	
	Wiring	Connectable	Connectable	Connectable	Connectable	
	After-cool & After-heat Control	Available	Available	Available	Not available	
Heat Exchange Element		—	Energy savings obtained		Energy savings obtained	
Humidifier		—	Fitted	—	—	
High Efficiency Filter		Option	Option		Option	
Ventilation System		Air supply only	Air supply & air exhaust		Air supply & air exhaust	
Power Supply		220-240 V, 50 Hz	220-240 V, 50 Hz		220-240 V/220 V, 50 Hz/60 Hz	
Airflow Rate					150 m ³ /h	
					250 m ³ /h	
					350 m ³ /h	
				500 m ³ /h		500 m ³ /h
						650 m ³ /h
				800 m ³ /h		800 m ³ /h
			1080 m ³ /h 1680 m ³ /h 2100 m ³ /h	1000 m ³ /h		1000 m ³ /h 1500 m ³ /h 2000 m ³ /h

*Refers to bringing outdoor air to near indoor temperature and delivering to a room.

Outdoor-Air Processing Unit

For outdoor units of 8 class and above

Combine fresh air treatment and air conditioning, supplied from a single system.

Line up

Model Name	FXMQ125MFV1	FXMQ200MFV1	FXMQ250MFV1
Capacity Index	125	200	250

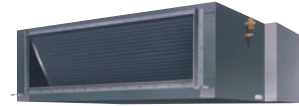

Fresh air treatment and air conditioning can be achieved with a single system by using heat pump technology—without the usual troublesome air supply and air discharge balance design. Fan coil units for air conditioning and an outdoor-air processing unit can be connected to the same refrigerant line. The results are enhanced design flexibility and a significant reduction in total system costs.

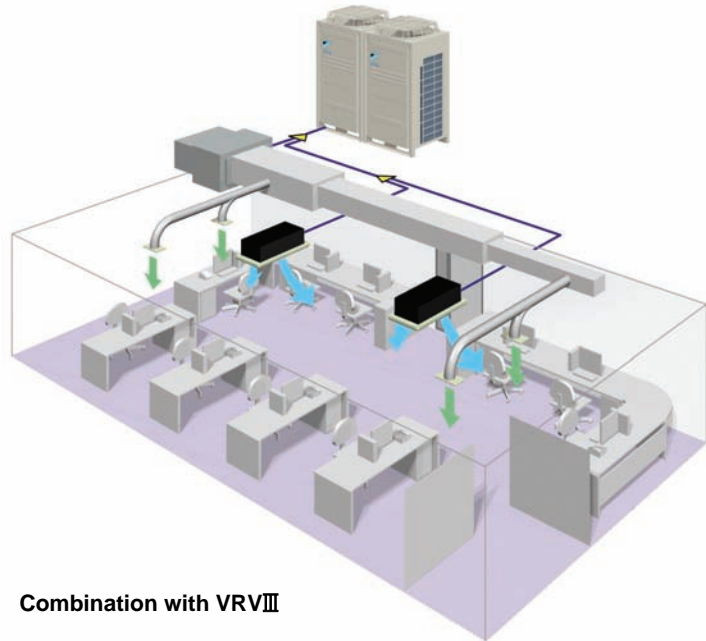

Combination with VRVIII

Air conditioning and outdoor air processing can be accomplished using a single system.

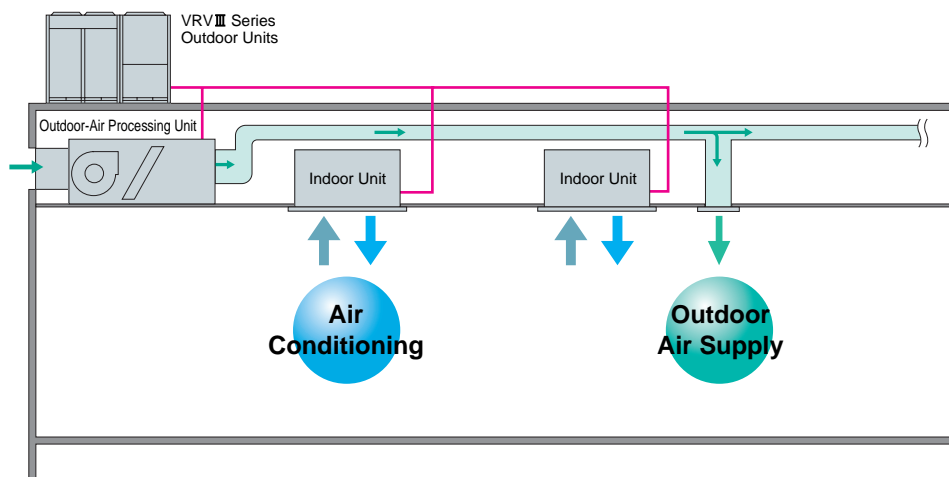

Connection Conditions

The following restrictions must be observed in order to maintain the indoor units connected to the same system.

- When outdoor-air processing units are connected, the total connection capacity index must be 50% to 100% of the capacity index of the outdoor units.
- When outdoor-air processing units and standard indoor units are connected, the total connection capacity index of the outdoor-air processing units must not exceed 30% of the capacity index of the outdoor units.
- Outdoor-air processing units can be used without indoor units.
- Connectable outdoor units: VRV II and III systems.

- The unit introduces outdoor air and adjusts the outdoor air temperature via fixed discharge temperature control, thereby reducing the air conditioning load.
- * The system can operate with outdoor-air temperatures ranging from -5 to 43°C. Heating performance is somewhat reduced when the outdoor-air temperature is 0°C or below.
- * When shipped from the factory, the thermostat is set at 18°C for cooling and 25°C for heating. The set temperature can be varied within the range of 13–25°C during cooling operation, and 18–30°C during heating operation, in the local setting mode using the wired remote controller. The temperature, however, is not displayed on the remote controller.
- * While in machine protection mode and depending on outdoor air conditions, discharge air temperature may not be at the set temperature.
- * The fan stops when operating in defrosting, oil returning and hot start operations. The fan also may stop due to mechanical protection control.

- Ceiling mounted duct units with three differing capacities are available. These can be connected to VRV series outdoor units to meet a variety of different requirements.

Airflow rate

FXMQ125MFV1	1,080 m ³ /h
FXMQ200MFV1	1,680 m ³ /h
FXMQ250MFV1	2,100 m ³ /h

- Optional equipment includes long-life filters.
- Compatible with outdoor temperatures from -5°C to 43°C.

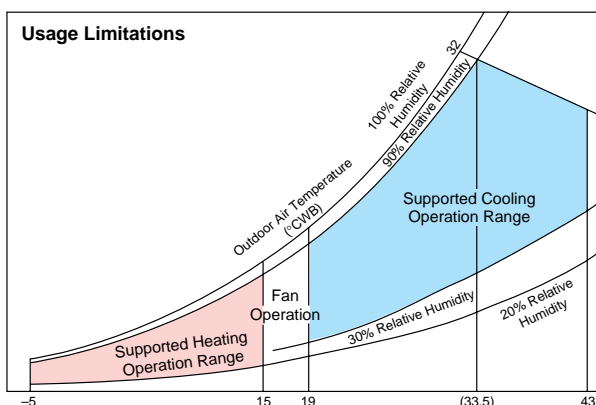

Notes:

1. The data shown in the graph illustrates the supported operation ranges under the following conditions.
Indoor and Outdoor Unit
Effective piping length: 7.5 m
Height differential: 0 m
2. The discharge temperature can be set using the remote controller. However, the actual temperature may not match the temperature setting under some circumstances due to the outdoor-air processing load or mechanical protection controls.
3. The system will not operate in fan mode when the outdoor air temperature is 5°C or below.

- High-performance filters with dust collection efficiencies (JIS calorimetry) of 90% and 65% are also available as options.

- As with the VRV^{III} system, a variety of control systems can be used, including remote control from distances of up to 500 m.



BRC1C62
(Wired remote controller)
(option)

- * Group control is not possible between this unit and standard type indoor units. Connect remote controllers to each unit.

- The "self-diagnosis function" indicates the occurrence and nature of abnormalities in the system by displaying codes on the remote controller.

- A central control system compatible with the VRV^{III} system can be installed.



DCS302CA61
Central remote controller
(option)

- * It is not possible to change the discharge air temperature settings from the central control system.
- * Do not associate this equipment into zones with standard indoor units, as central control will not be possible.

- As with the VRV^{III} system, the equipment employs the "super wiring system" so that the wiring linking indoor and outdoor units can also be utilised for central control.

Notes:

- * Linked control of the product and the Heat Reclaim Ventilator is not supported.
- * This equipment is intended for the treatment of outdoor air only. It is not to be used for maintaining indoor air temperature. Install and use with standard indoor units. Be sure to position the air discharge openings of the product in positions where the airflow will not blow on people directly. When outdoor-air processing is in excess, the unit switches to thermo-off mode, and outdoor air flows into the room directly.
- * For outdoor ducts, be sure to provide heat insulation to prevent condensation.
- * Group control of the product and the standard indoor units is not supported. A separate remote controller should be connected to each individual unit.
- * The system will not operate in fan mode when the outdoor air temperature is 5°C or below.
- * If the product is allowed to operate 24 hours a day, maintenance (part replacement, etc.) must be performed periodically.
- * Temperature setting and Power Proportional Distribution (PPD) are not possible even if the intelligent Touch Controller or the intelligent Touch Manager is installed.
- * The remote controller wired to the outdoor-air processing unit must not be set as the master remote controller. Otherwise, when set to "Auto," the operation mode will switch according to the outdoor air conditions, regardless of the indoor temperature.

STANDARD SPECIFICATIONS

Indoor unit

Type		Ceiling Mounted Duct Type					
Model		FXMQ125MFV1	FXMQ200MFV1	FXMQ250MFV1			
Power supply		1-phase, 220-240 V (also required for indoor units), 50 Hz					
Cooling capacity *1	kcal/h	12,000	19,300	24,100			
	Btu/h	47,800	76,400	95,500			
	kW	14.0	22.4	28.0			
Heating capacity *1	kcal/h	7,700	12,000	15,000			
	Btu/h	30,400	47,400	59,400			
	kW	8.9	13.9	17.4			
Power consumption		kW	0.359	0.548	0.638		
Casing		Galvanised steel plate					
Dimensions (HxWxD)		mm	470x744x1,100	470x1,380x1,100			
Fan	Motor output		kW		0.380		
	Airflow rate			ℓ/s	300	466	583
				m ³ /min	18	28	35
	External static pressure	240 V	Pa	225	275	255	
Air filter		*2					
Refrigerant piping	Liquid	mm	φ 9.5 (flare)				
	Gas	mm	φ 15.9 (flare)	φ 19.1 (brazing)	φ 22.2 (brazing)		
	Drain	mm	PS1B female thread				
Machine weight		kg	86	123			
Sound level *3		240 V	dB(A)	43	48		
Connectable outdoor units *4 *5		RX(Y)Q8-54PAY1, RX(Y)Q16-50PAHY1		RX(Y)Q10-54PAY1, RX(Y)Q16-50PAHY1			
Operation temperature range (Fan mode operation between 15 and 19°C)		Cooling	19 to 43°C				
		Heating	-5 to 15°C				
Range of the discharge temperature *6		Cooling	13 to 25°C				
		Heating	18 to 30°C				

Notes: *1. Specifications are based on the following conditions;

- Cooling: Outdoor temp. of 33°CDB, 28°CWB (68% RH), and discharge temp. of 18°CDB. • Heating: Outdoor temp. of 0°CDB, -2.9°CWB (50% RH), and discharge temp. of 25°CDB.
- Equivalent reference piping length: 7.5 m (0 m horizontal)

*2. An intake filter is not supplied, so be sure to install the optional long-life filter or high-efficiency filter.

Please mount it in the duct system of the suction side. Select a dust collection efficiency (gravity method) of 50% or more.

*3. Anechoic chamber conversion value, measured at a point 1.5 m downward from the unit centre.

These values are normally somewhat higher during actual operation as a result of ambient conditions.

*4. It is possible to connect to the outdoor unit if the total capacity of the indoor units is 50% to 100% of the capacity index of the outdoor unit.

*5. It is not possible to connect to the 5 class or 6 class outdoor unit.

*6. Local setting mode. Not displayed on the remote controller.

• This equipment cannot be incorporated into the remote group control of the VRVⅢ system.

OPTIONS

Indoor unit

Model		FXMQ125MFV1	FXMQ200MFV1	FXMQ250MFV1
Operation/control	Operation remote controller	BRC1C62/BRC1D61		
	Central remote controller	DCS302CA61		
	Unified ON/OFF controller	DCS301BA61		
	Schedule timer	DST301BA61		
	Wiring adaptor for electrical appendices (1)	KRP2A61		
	Wiring adaptor for electrical appendices (2)	KRP4AA51		
	Filters	Long-life replacement filter	KAFJ371L140	KAFJ371L280
High-efficiency filter		Colourimetric method 65%	KAFJ372L140	KAFJ372L280
		Colourimetric method 90%	KAFJ373L140	KAFJ373L280
Filter chamber *1		KDJ3705L140	KDJ3705L280	
Drain pump kit		KDU30L250VE		
Adaptor for wiring		KRP1B61		

Notes: *1. Filter chamber has a suction-type flange. (Main unit does not.)

- Dimensions and weight of the equipment may vary depending on the options used.
- Some options may not be usable due to the equipment installation conditions, so please confirm prior to ordering.
- Some options may not be used in combination.
- Operating sound may increase somewhat depending on the options used.

DIMENSIONS

■ FXMQ125/200/250MFV1

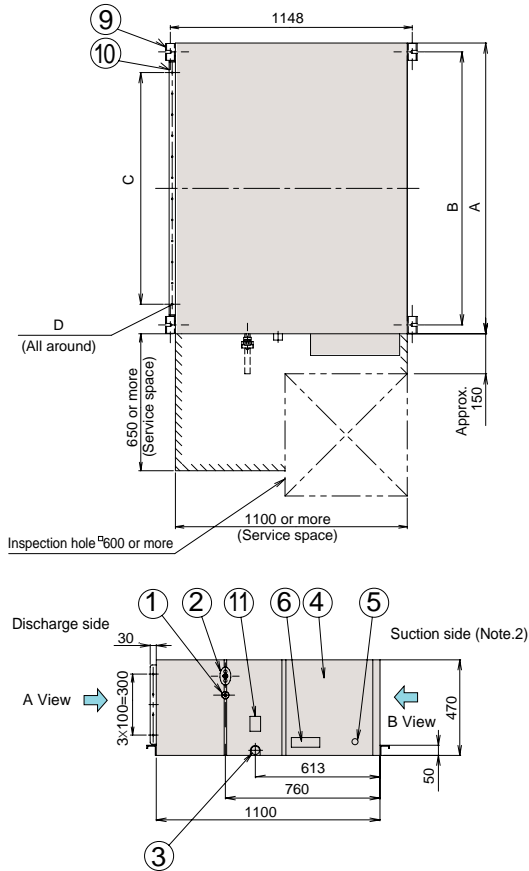

*These diagrams are based on FXMQ200 and FXMQ250MFV1.

Local connection piping size

Model	Gas piping diameter	Liquid piping diameter
FXMQ125MFV1	φ 15.9	φ 9.5
FXMQ200MFV1	φ 19.1 attached piping	φ 9.5
FXMQ250MFV1	φ 22.2 attached piping	φ 9.5

Table of dimensions

Model	A	B	C	D
FXMQ125MFV1	744	685	5X100=500	20-φ4.7 hole
FXMQ200MFV1	1380	1296	11X100=1100	32-φ4.7 hole
FXMQ250MFV1	1380	1296	11X100=1100	32-φ4.7 hole

Notes:

- The attached piping in the diagram is for FXMQ200MFV1 and FXMQ250MFV1 only. The gas piping connection port (② in the diagram) has a different bore form with FXMQ125MFV1.
- An air filter is not supplied with this unit. Be sure to mount an air filter in the suction side. [Use a filter with dust collection efficiency of at least 50% (gravimetric method). This is available as an option.]
- For outdoor ducts, be sure to provide heat insulation to prevent condensation.

- | | |
|---------------------------|----------------------------------|
| ① Liquid pipe connection | ⑦ Power supply wiring connection |
| ② Gas pipe connection | ⑧ Transmission wiring connection |
| ③ Drain piping connection | ⑨ Hanger bracket |
| ④ Electric parts box | ⑩ Discharge companion flange |
| ⑤ Ground terminal | ⑪ Water supply port |
| ⑥ Name plate | ⑫ Attached piping (Note. 1) |

FXMQ200/250MFV1

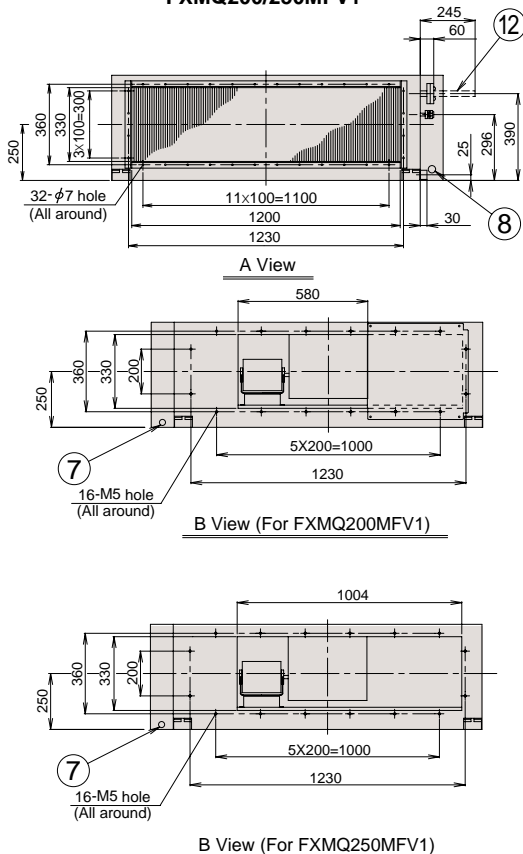

FXMQ125MFV1

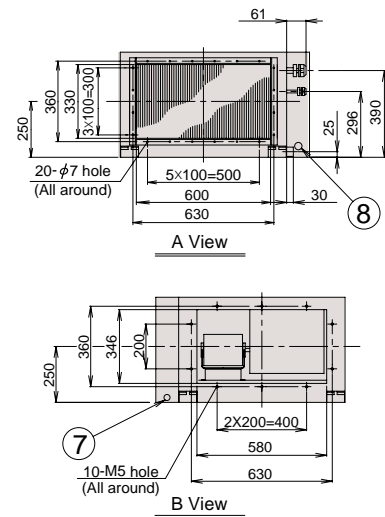

Heat Reclaim Ventilator with DX-Coil and Humidifier — VKM series

The Heat Reclaim Ventilator lineup features the DX-coil in response to recently diversifying outdoor air introduction requirements.

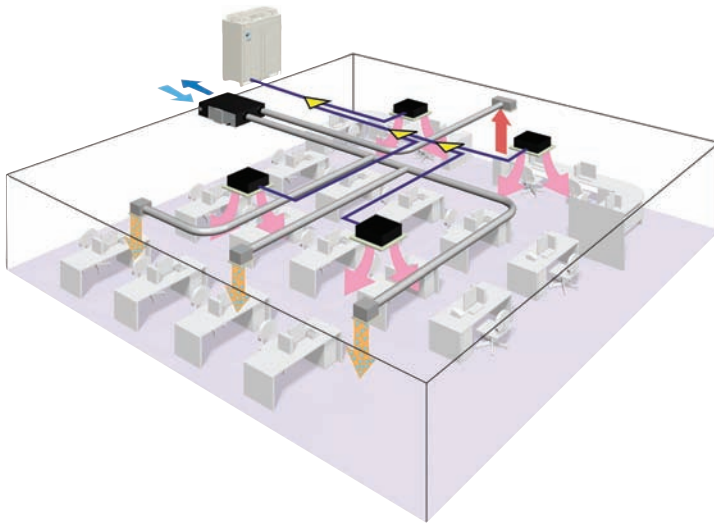

Efficient outdoor air introduction is possible

Heat Reclaim Ventilator (VKM series) series introduces fresh outdoor air with minimum heat losses, while a wide variety of features respond to customer requirements.

Line up

With DX Coil & Humidifier Type			
Model Name	VKM50GAMV1	VKM80GAMV1	VKM100GAMV1
Capacity Index	31.25	50	62.5

With DX Coil Type			
Model Name	VKM50GAV1	VKM80GAV1	VKM100GAV1
Capacity Index	31.25	50	62.5



Humidifier

The lineup includes models with a humidifier, in response to diversifying customer requirements. (VKM50/80/100GAMV1 only)

DX-coil

The Heat Reclaim Ventilator features DX-coil that contributes to the prevention of cold airflow hitting people directly during heating operation, due to the after-cool, after-heat operations done beforehand.

High static pressure

High external static pressure means enhanced design flexibility.

Air conditioning and outdoor air processing can be accomplished using a single system.

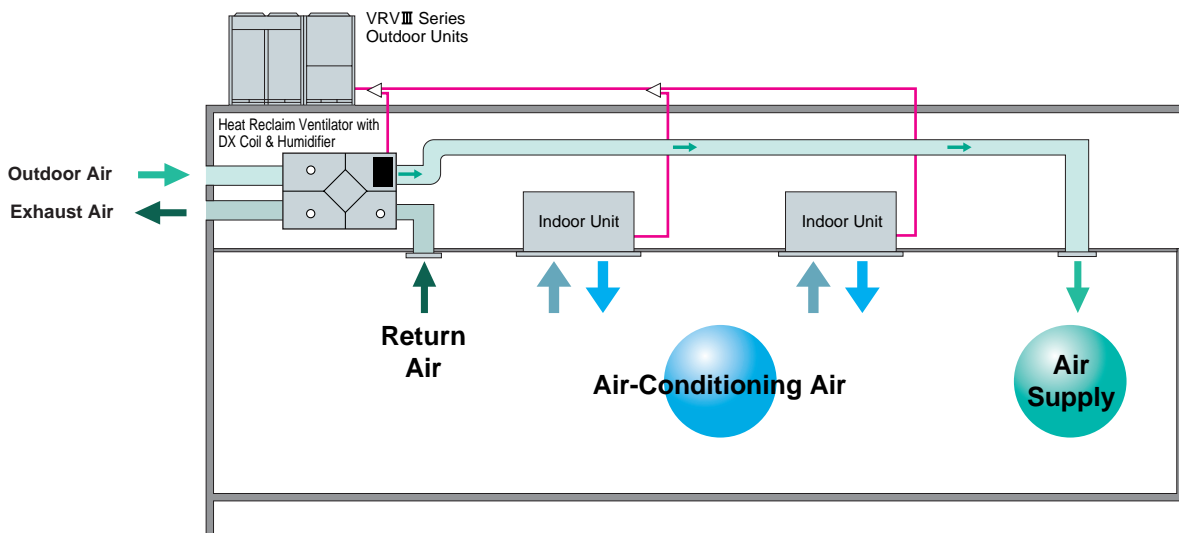

Connection Conditions

The following restrictions must be observed in order to maintain the indoor units connected to the same system.

- When Heat Reclaim Ventilator VKM series units are connected, the total connection capacity index must be 50% to 130% of the capacity index of the outdoor units.

A compact unit packed with Daikin's cutting-edge technologies



HEP Element
(Anti-mould)

Operation of the heat exchanger element

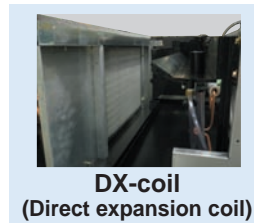
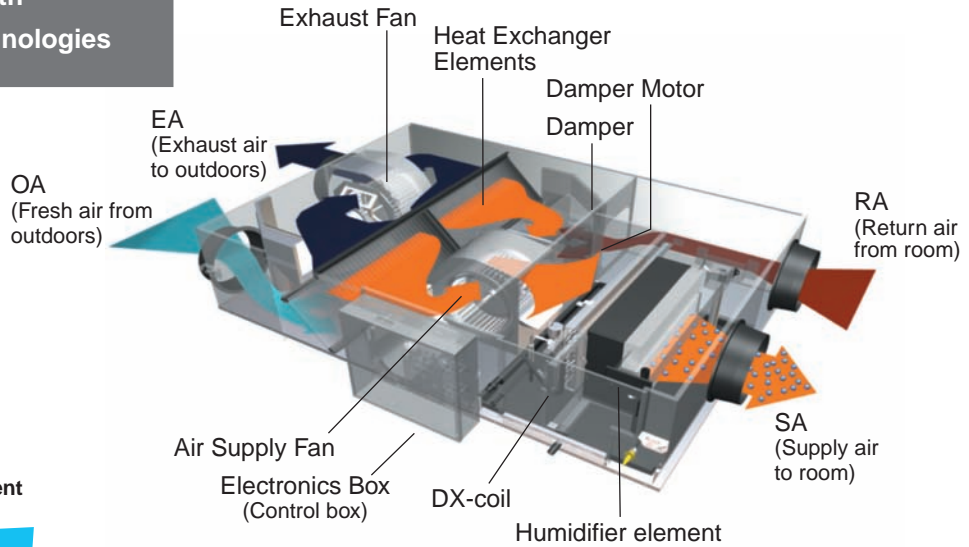
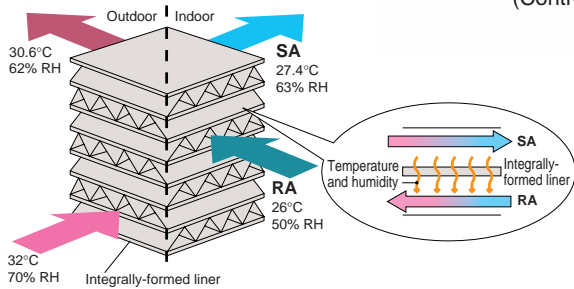

Heating and humidification process

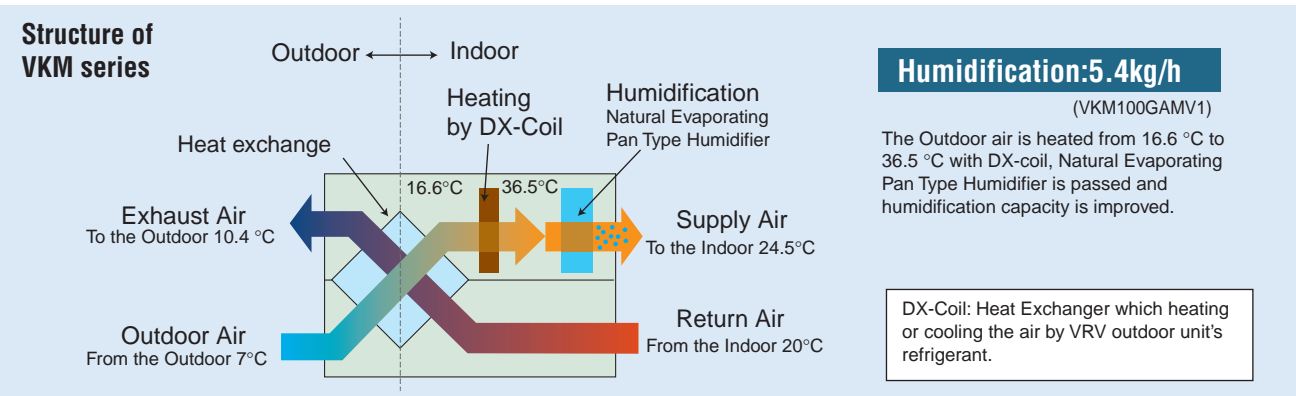

Efficient outdoor air introduction with heat exchanger and cooling/heating operation

Indoor unit with outdoor air treatment
Using outdoor air, the temperature can be brought near room temperature with minimal cooling capacity through the use of outdoor air.

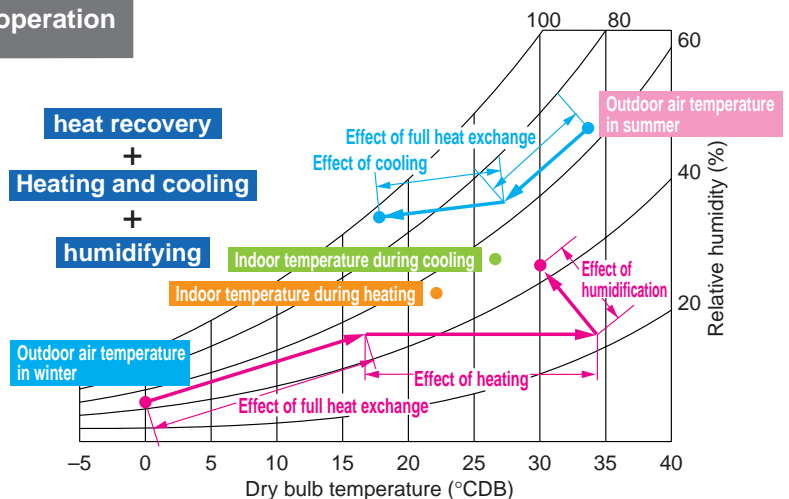

Other features

- Integrated system includes ventilation and humidifying operations.
- Ventilation, cooling/heating and humidifying are possible with one remote controller.

Air Treatment Equipment Lineup

SPECIFICATIONS

MODEL				VKM50GAMV1*	VKM80GAMV1*	VKM100GAMV1*	VKM50GAV1	VKM80GAV1	VKM100GAV1
Refrigerant				R-410A					
Power Supply				1-phase, 220–240 V, 50 Hz					
Airflow Rate & Static Pressure (Note 7)	Ultra-high	Airflow rate	(m ³ /h)/(ℓ/s)	500/138	750/208	950/263	500/138	750/208	950/263
		Static pressure	Pa	160	140	110	180	170	150
	High	Airflow rate	(m ³ /h)/(ℓ/s)	500/138	750/208	950/263	500/138	750/208	950/263
		Static pressure	Pa	120	90	70	150	120	100
	Low	Airflow rate	(m ³ /h)/(ℓ/s)	440/122	640/177	820/227	440/122	640/177	820/227
		Static pressure	Pa	100	70	60	110	80	70
Power Consumption	Heat exchange mode	Ultra-high	W	560	620	670	560	620	670
		High	W	490	560	570	490	560	570
		Low	W	420	470	480	420	470	480
	Bypass mode	Ultra-high	W	560	620	670	560	620	670
		High	W	490	560	570	490	560	570
		Low	W	420	470	480	420	470	480
Fan Type				Sirocco Fan					
Motor Output				kW					
				0.280 × 2	0.280 × 2	0.280 × 2	0.280 × 2	0.280 × 2	0.280 × 2
Sound Level (Note 5) (230/240 V)	Heat exchange mode	Ultra-high	dB(A)	37.5/38	39/40	39.5/40	38.5/39	41/41.5	40.5/41
		High	dB(A)	35.5/36	37/37.5	37.5/38	36.5/37	38/39	38.5/39
		Low	dB(A)	33/34	34/35.5	34.5/35.5	34.5/35.5	36/37	36/36.5
	Bypass mode	Ultra-high	dB(A)	37.5/38	39/40	39.5/40	38.5/39	41/41.5	40.5/41
		High	dB(A)	35.5/36	37/37.5	37.5/38	36.5/37	38/39	38.5/39
		Low	dB(A)	33/34	34/35.5	34.5/35.5	34.5/35.5	36/37	36/36.5
Humidification Capacity (Note 4)				kg/h					
				2.7	4.0	5.4	—	—	—
Temp. Exchange Efficiency	Ultra-high	%		76	78	74	76	78	74
	High			76	78	74	76	78	74
	Low			77.5	79	76.5	77.5	79	76.5
Enthalpy Exchange Efficiency (Cooling)	Ultra-high	%		64	66	62	64	66	62
	High			64	66	62	64	66	62
	Low			67	68	66	67	68	66
Enthalpy Exchange Efficiency (Heating)	Ultra-high	%		67	71	65	67	71	65
	High			67	71	65	67	71	65
	Low			69	73	69	69	73	69
Casing				Galvanised Steel Plate					
Insulating Material				Self-Extinguishable Urethane Foam					
Heat Exchanging System				Air to Air Cross Flow Total Heat (Sensible + Latent Heat) Exchange					
Heat Exchanger Element				Specially Processed Nonflammable Paper					
Air Filter				Multidirectional Fibrous Fleeces					
DX-coil Capacity	Cooling (Note 2)	kW		2.8	4.5	5.6	2.8	4.5	5.6
	Heating (Note 3)			3.2	5.0	6.4	3.2	5.0	6.4
Dimensions	Height	mm		387	387	387	387	387	387
	Width			1,764	1,764	1,764	1,764	1,764	1,764
	Depth			832	1,214	1,214	832	1,214	1,214
Connection Duct Diameter				mm					
				ø200	ø250		ø200	ø250	
Machine Weight	Net	kg		102	120	125	96	109	114
	Gross (Note 8)			107	129	134	—	—	—
Unit Ambient Condition	Around Unit	0°C–40°C DB, 80%RH or less							
	OA (Note 9)	-15°C–40°C DB, 80%RH or less							
	RA (Note 9)	0°C–40°C DB, 80%RH or less							
Connectable outdoor units				RX(Y)Q5-54PAY1, RX(Y)Q16-50PAHY1					

Note: 1. Cooling and heating capacities are based on the following conditions. Fan is based on High and Ultra-high.

When calculating the capacity as indoor units, use the following figures:

VKM50GAMV1/GV1: 3.5 kW, VKM80GAMV1/GV1: 5.6 kW, VKM100GAMV1/GV1: 7.0 kW

2. Indoor temperature: 27°C DB, 19°C WB, Outdoor temperature: 35°C DB

3. Indoor temperature: 20°C DB, Outdoor temperature: 7°C DB, 6°C WB

4. Humidifying capacity is based on the following conditions:

Indoor temperature: 20°C DB, 15°C WB, Outdoor temperature: 7°C DB, 6°C WB

5. The operating sound measured at the point 1.5 m below the centre of the unit is converted to that measured in an anechoic chamber built in accordance with the JIS C 1502 conditions. The actual operating sound varies depending on the surrounding conditions (near running unit's sound, reflected sound and so on) and is normally higher than this value.

For operation in a quiet room, it is required to take measures to lower the sound.

For details, refer to the Engineering Data.

6. The noise level at the air discharge port is about 8–11 dB(A) or higher than the unit's operating sound.

For operation in a quiet room, it is required to take measures to lower the sound.

7. Airflow rate can be changed over to Low mode or High mode.

8. In case of holding full water in humidifier.

9. OA: fresh air from outdoor, RA: return air from room.

10. Specifications, design and information here are subject to change without notice.

11. Power consumption and efficiency depend on the above value of airflow rate.

12. Temperature exchange efficiency is the mean value for Cooling and Heating. Efficiency is measured under the following condition: Ratio of rated external static pressure outdoor to indoor is kept constant at 7 to 1.

13. In heating operation, freezing of the outdoor unit's coil increases. Heating capability decreases and the system goes into defrost operation. During defrost operation, the fans of the unit continues driving (factory setting). The purpose of this is to maintain the amount of ventilation and humidifying.

14. When connecting with a VRV system heat recovery outdoor unit and bringing the RA (exhaust gas intake) of this unit directly in from the ceiling, connect to a BS unit identical to the VRV indoor unit (master unit), and use group-linked operation. (See the Engineering Data for details.)

15. When connecting the indoor unit directly to the duct, always use the same system on the indoor unit as with the outdoor unit, perform group-linked operation, and make the direct duct connection settings from the remote controller. (Mode No. "17 (27)" – First code No. "5" – Second code No. "6".) Also, do not connect to the outlet side of the indoor unit. Depending on the fan strength and static pressure, the unit might back up.

★ Feed clean water (city water, tap water or equivalent). Dirty water may clog the valve or cause dirt deposits in the water container, resulting in poor humidifier performance. (Never use any cooling tower water and heating-purpose water.) Also, if the supply water is hard water, use a water softener because of short life.

* Life of humidifying element is about 3 years (4,000 hours) under the supply water conditions of hardness: 150 mg/L. (Life of humidifying element is about 1 year (1,500 hours) under the supply water conditions of hardness: 400 mg/L.) Annual operating hours: 10 hours/day x 26 days/month x 5 months = 1,300 hours

DIMENSIONS

VKM50/80/100GA(M)V1

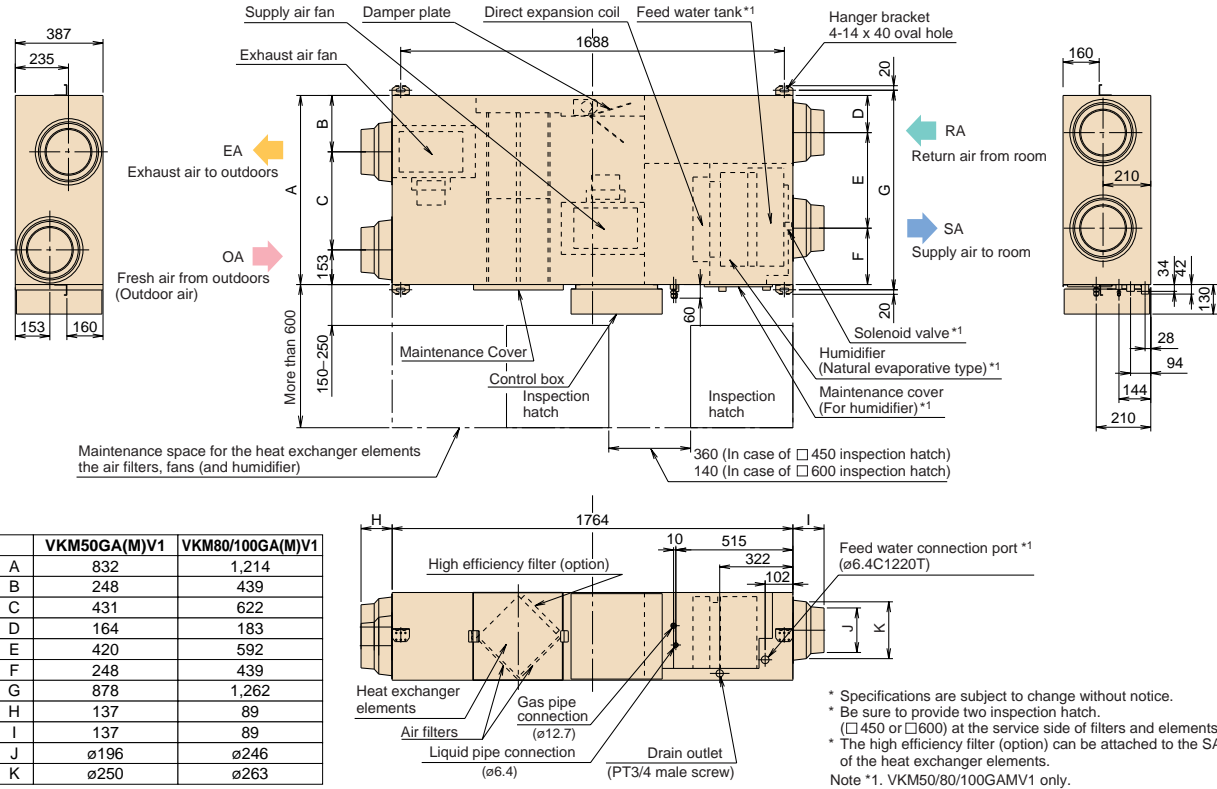

OPTIONS

Item		Type	VKM50/80/100GA(M)V1												
Controlling device	Remote controller		BRC1C62/BRC1D61 *1												
	Centralised controlling device	Residential central remote controller	DCS303A51 *2												
		Central remote controller	DCS302CA61												
		Unified ON/OFF controller	DCS301BA61												
		Schedule timer	DST301BA61												
	PC Board Adaptor	Wiring adaptor for electrical appendices	KRP2A61												
		For humidifier running ON signal output	KRP50-2												
		For heater control kit	BRP4A50												
	For wiring	Type (indoor unit of VRV)	FXFQ-P	FXZQ-M	FXCQ-M	FXKQ-MA	FXDQ-PB FXDQ-NB	FXSYQ-M	FXDYQ-M(A)	FXMQ-P	FXMQ-MA	FXHQ-MA	FXAQ-P	FXLQ-MA FXNQ-MA	FXUQ-MA
			KRP1C63*	KRP1BA57*	KRP1B61*	KRP1B61	KRP1B56*	KRP1B61	KRP1C64*	KRP1B61	KRP1BA54	—	KRP1B61	—	
Installation box for adaptor PCB*		Notes 2, 3 KRP1H98	Notes 4, 6 KRP1BA101	Notes 2, 3 KRP1B96	—	Notes 4, 6 KRP1BA101	Note 5 KRP4A91	—	Notes 2, 3 KRP4A96	—	Note 3 KRP1CA93	Notes 2, 3 KRP4AA93	—	KRP1BA97	

- Note: 1. Installation box ☆ is necessary for each adaptor marked ☆.
 2. Up to 2 adaptors can be fixed for each installation box.
 3. Only one installation box can be installed for each indoor unit.
 4. Up to 2 installation boxes can be installed for each indoor unit.
 5. Installation box ☆ is necessary for second adaptor.
 6. Installation box ☆ is necessary for each adaptor.
 7. *1 Necessary when operating Heat Reclaim Ventilator (VKM) independently. When operating interlocked with other air conditioners, use the remote controllers of the air conditioners.
 *2 For residential use only. When connected with Heat Reclaim Ventilator (VKM), you can only switch the power ON/OFF. Cannot be used with other centralised control equipment.

Item		Type	VKM50GA(M)V1	VKM80GA(M)V1	VKM100GA(M)V1	
Additional function	Silencer		—	—	KDDM24B100	
	Air suction/ Discharge grille	Nominal pipe diameter	mm	—	—	φ 250 mm
		White		K-DGL200B	—	K-DGL250B
	High efficiency filter	Nominal pipe diameter	mm	φ 200	—	φ 250
Air filter for replacement			KAF242H80M	—	KAF242H100M	
Flexible duct (1 m)			K-FDS201D	—	K-FDS251D	
Flexible duct (2 m)			K-FDS202D	—	K-FDS252D	

Heat Reclaim Ventilator — VAM series

*The Heat Reclaim Ventilator
Creates a High-Quality
Environment by Interlocking
with the Air Conditioner*

Improved Enthalpy Efficiency
Higher External Static Pressure ^{*2}
Enhanced Energy Saving Functions

Model Names

VAM150GJVE, VAM250GJVE, VAM350GJVE,
VAM500GJVE, VAM650GJVE, VAM800GJVE,
VAM1000GJVE, VAM1500GJVE, VAM2000GJVE



Heat Reclaim Ventilator remote controller*
BRC301B61 (Option)

* This remote controller is used in case of independent operation of Heat Reclaim Ventilator.

This VAM series provides higher enthalpy efficiency^{*1}, due to the greatly enhanced performance of the thin film element. Furthermore, improved external static pressure^{*2} offers more flexibility for installation. Along with these three outstanding improvements, the nighttime free cooling operation contributes to energy conservation and more comfortable space.

^{*1} For models: VAM150/250/350/650/800/1000/2000GJVE
^{*2} For models: VAM150/350/500GJVE

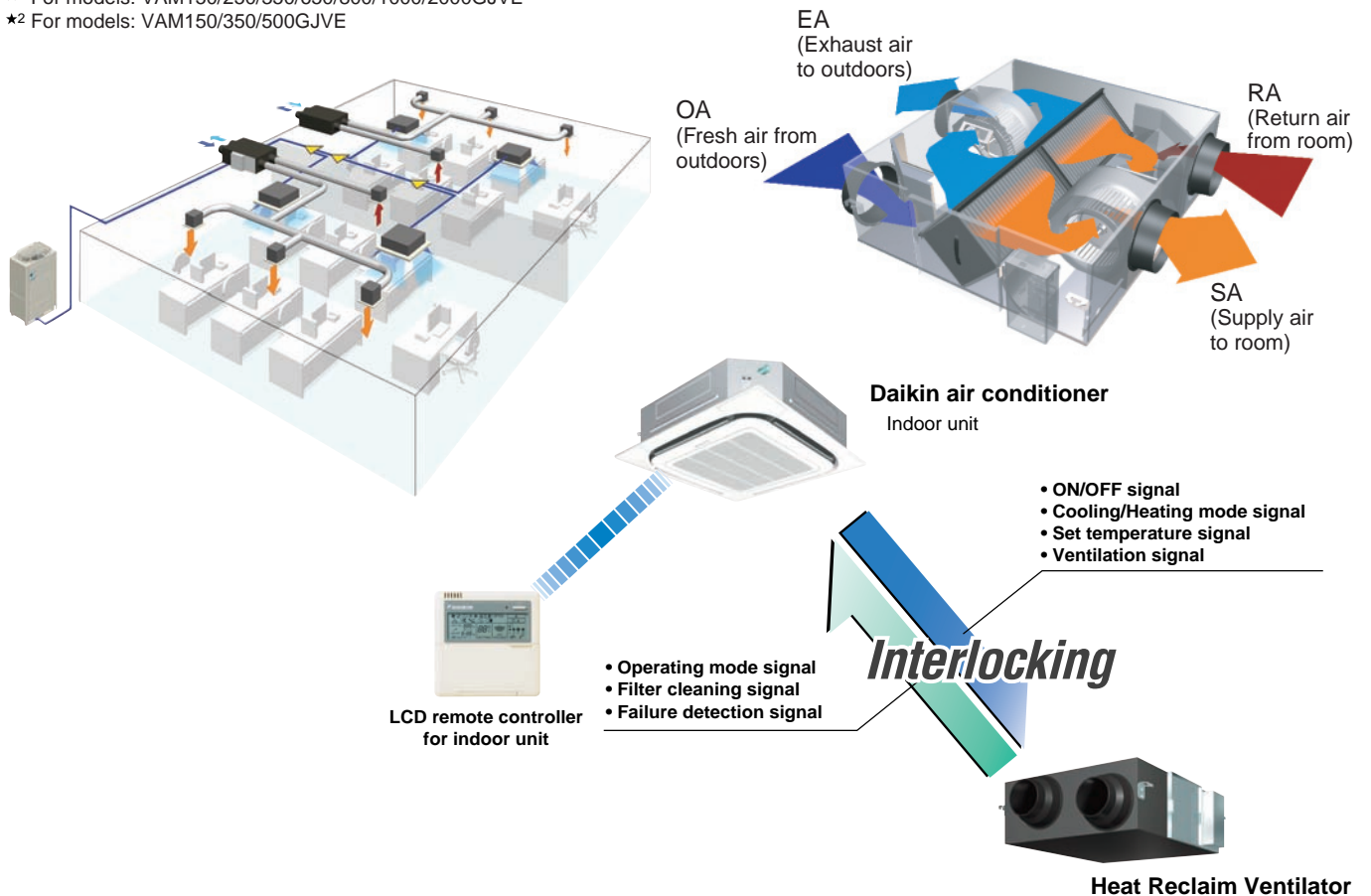

Compact Equipment

With a height of just 306 mm, the unit easily fits in limited spaces, such as above ceilings.



* For VAM500GJVE

Energy Conservation

Air conditioning load reduced by approximately 31%!

Cold Climate Compatible

Standard operation at temperatures down to -15°C.

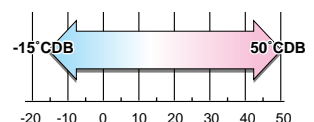

Air conditioning load reduced by approximately 31%!

Total heat exchange ventilation

This unit recovers heat energy lost through ventilation and curbs room temperature changes caused by ventilation, thereby conserving energy and reducing the load on the air conditioning system.

Enthalpy efficiency drastically improved by employing thin film element! (VAM-GJ model)

Due to the thinner film...

- Decreases the moisture resistance of the partition sheets drastically.
- Realises more space for extra layers in the element, resulting in increased effective area that supply and exhaust air can be exposed to.

Moisture absorption increased by approx. 10%!

23%

Auto-ventilation Mode Changeover Switching

6%

Automatically switches the ventilation mode (Total Heat Exchange Mode/Bypass Mode) according to the operating status of the air conditioner.



Pre-cool, Pre-heat Control

2%

Reduces air conditioning load by not running the Heat Reclaim Ventilator while air is still clean soon after the air conditioner is turned ON.

Thickness of the partition sheet
40 μm

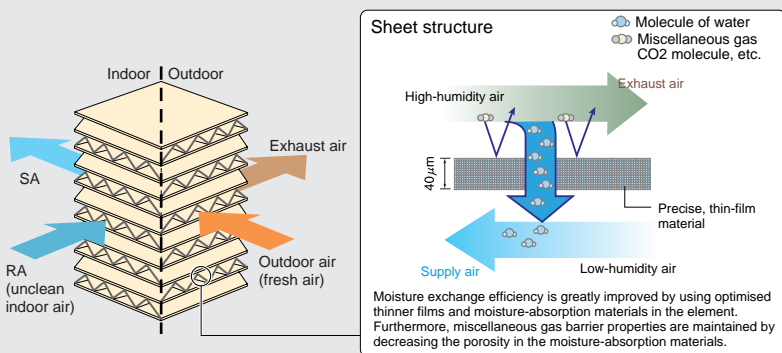

- The air conditioning load reduction values may vary according to weather and other environmental conditions at the location of the machine's installation.
- The air conditioning load reduction values are based on the following conditions;
 - Application: Tokyo office building
 - Building form: 2 floors above ground, 6 floors underground, floor area 2,100 m²
 - Personnel density: 0.25 person/m²
 - Ventilation volume: 25 m³/h
 - Indoor air conditioning level: summer 25°C 50% RH, intermediate seasons 24°C 50% RH, winter 22°C 40% RH
 - Operating time: 2745 hours (9 hours per day, approx. 25 days per month)
 - Calculation method: simulation based on "MICRO-HASP/1982" of the Japan Building Mechanical and Electrical Engineers Association.

Air Conditioning Load Reduced by Approximately 31%

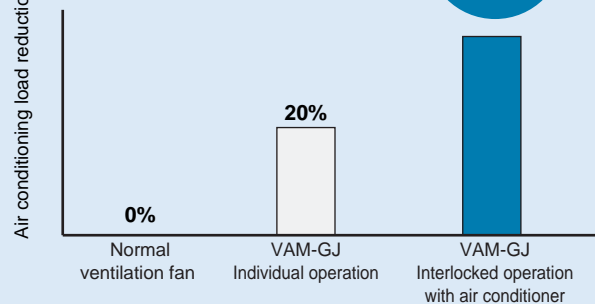

Nighttime free cooling operation*1

Nighttime free cooling operation is an energy-conserving function that works at night when air conditioners are off. By ventilating rooms containing office equipment that raises the room temperature, nighttime free cooling operation reduces the cooling load when air conditioners are turned on in the morning. It also alleviates feelings of discomfort in the morning caused by heat accumulated during the night.

- Nighttime free cooling operation only works to cool and if connected to Building Multi or VRV systems.
- Nighttime free cooling operation is set to "off" in the factory settings, so if you wish to use it, request your dealer to turn it on.

*1 This function can be operated only when interlocked with air conditioners.

*2 Value is based on the following conditions:

- Cooling operation performed from April to October.
- Calculated for air conditioning sensible heat load only (latent heat load not included).

Air conditioning sensible heat load reduced by **approx. 5%*2!**

The indoor accumulated heat is discharged at night. This reduces the air conditioning load the next day thereby increasing efficiency.

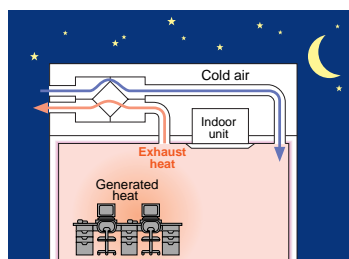

Heat is discharged.

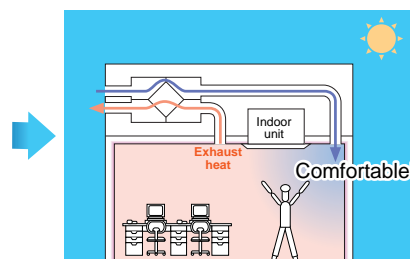

The load is small so the temperature is rapidly reduced to a comfortable level.

*Interlocked operation with an air conditioner

Air Treatment Equipment Lineup

SPECIFICATIONS

MODEL		VAM150GJVE	VAM250GJVE	VAM350GJVE	VAM500GJVE	VAM650GJVE	VAM800GJVE	VAM1000GJVE	VAM1500GJVE	VAM2000GJVE	
Power Supply		1-phase, 220-240 V/220 V, 50 Hz/60 Hz									
Temp. Exchange Efficiency	Ultra-High	79	75	79	74	75	72	78	72	77	
	High	79	75	79	74	75	72	78	72	77	
	Low	84	79	82	80	77	74	80.5	75.5	79	
Enthalpy Exchange Efficiency	For Heating	Ultra-High	72	71	70	67	67.5	65	70	65	72
		High	72	71	70	67	67.5	65	70	65	72
		Low	76	74	77	74	71.5	67.5	72.5	67	75
	For Cooling	Ultra-High	66	63	66	55	61	61	64	61	62
		High	66	63	66	55	61	61	64	61	62
		Low	70	66	70	59	64	64	68.5	64	66
Power Consumption	Heat Exchange Mode	Ultra-High	125	137	200	248	342	599	635	1,145	1,289
		High	111	120	182	225	300	517	567	991	1,151
		Low	57	60	122	128	196	435	476	835	966
	Bypass Mode	Ultra-High	125	137	200	248	342	599	635	1,145	1,289
		High	111	120	182	225	300	517	567	991	1,151
		Low	57	60	122	128	196	435	476	835	966
Sound Level	Heat Exchange Mode	Ultra-High	27-28.5	27-29	31.5-33	33-35.5	34-36	39-40.5	39.5-41.5	39.5-41.5	41.5-43.5
		High	26-27.5	26-27.5	30-31.5	31.5-34	33-34.5	37-39.5	37.5-39.5	37.5-39.5	39-43
		Low	20.5-21.5	21-22	23-25	25-28.5	27.5-29.5	35-37.5	35-37.5	35-37.5	36-39
	Bypass Mode	Ultra-High	28.5-29.5	28.5-30.5	33-34.5	34.5-36	35-37.5	40.5-42	40.5-42.5	41-43	43-45.5
		High	27.5-28.5	27.5-29	31.5-33	33-34.5	33-35.5	38.5-40	38.5-40.5	39.5-41	40.5-45
		Low	22.5-23.5	22.5-23	24.5-26.5	25.5-28.5	27.5-30.5	36-38.5	36-38.5	36.5-38	37.5-39.5
Casing		Galvanised steel plate									
Insulation Material		Self-extinguishable polyurethane foam									
Dimensions (HXWXD)	mm	278×810×551		306×879×800		338×973×832	387×1,111×832	387×1,111×1,214	785×1,619×832	785×1,619×1,214	
Machine Weigh	kg	24		32		45	55	67	129	157	
Heat Exchange System		Air to air cross flow total heat (Sensible heat + latent heat) exchange									
Heat Exchange Element Material		Specially processed nonflammable paper									
Air Filter		Multidirectional fibrous fleeces									
Fan	Type	Sirocco fan									
	Airflow Rate	Ultra-High	150	250	350	500	650	800	1,000	1,500	2,000
		High	150	250	350	500	650	800	1,000	1,500	2,000
		Low	100	155	230	320	500	700	860	1,320	1,720
	Airflow Rate	Ultra-High	41	69	97	138	180	222	277	416	555
		High	41	69	97	138	180	222	277	416	555
		Low	27	43	63	88	138	194	238	366	477
	External Static Pressure	Ultra-High	120	70	169	105	85	133	168	112	116
		High	106	54	141	66	53	92	110	73	58
		Low	56	24	67	32	35	72	85	56	45
Motor Output	kW	0.030×2		0.090×2		0.140×2	0.280×2		0.280×4		
Connection Duct Diameter	mm	φ 100	φ 150		φ 200		φ 250		φ 350		
Unit Ambient Condition		-15°C-50°CDB, 80%RH or less									

Notes: 1. Sound level is measured at 1.5 m below the centre of the body.

2. Airflow rate can be changed over to Low mode or High mode.

3. Sound level is measured in an anechoic chamber.

Sound level generally becomes greater than this value depending on the operating conditions, reflected sound, and peripheral noise.

4. The sound level at the air discharge port is about 8 dB(A) higher than the unit's sound level.

5. The specifications, designs and information given here are subject to change without notice.

6. Temperature Exchange Efficiency is the mean value between cooling and heating.

7. Efficiency is measured under the following conditions:

Ratio of rated external static pressure has been maintained as follows; outdoor side to indoor side = 7 to 1.

8. In conformance with JIS standards (JIS B 8628), operating sound level is based on the value when one unit is operated, with the value converted for an anechoic chamber. This is transmission sound from the main unit, and does not include sound from the discharge grille. Thus it is normal for the sound to be louder than the indicated value when the unit is actually installed.

9. Sound level from the discharge port causes the value to be approximately 8 dB(A) (models with the airflow rate of less than 150 to 500 m³/h) to approximately 11 dB(A) (models with the airflow rate of 650 m³/h or more) greater than the indicated value. Furthermore, fan rotation and noise from the discharge grille may increase depending on the on-site duct resistance conditions. Please consider noise countermeasures when installing the unit.

10. With large models in particular (1500 and 2000 m³/h models), if the supply air (SA) grille is installed near the main unit, the noise of the main unit may be heard from the discharge grille via the duct, and this will result in a marked increase in noise. In such cases, if peripheral effects are included (such as reverberation of the floor and walls, combination with other equipment, and background noise), sound level may be as much as 15 dB(A) higher than the indicated value. When installing a large model, please provide as much separation as possible between the main unit and the discharge grille. If the equipment and discharge grille are near each other, please consider countermeasures such as the following:

- Use a sound-muffling box, flexible duct and sound-muffling air supply/discharge grilles
- Decentralised installation of discharge grilles

11. When installing in a location with particularly low background noise such as a classroom, please consider the following measures to avoid transmission sound from the main unit:

- Use of ceiling materials with high sound insulating properties (high transmission loss)
 - Methods of blocking sound transmission, for example, by adding sound insulating materials around the bottom of the sound source.
- Alternatively, consider supplementary methods such as installing the equipment in a different location (corridor, etc.)

OPTIONS

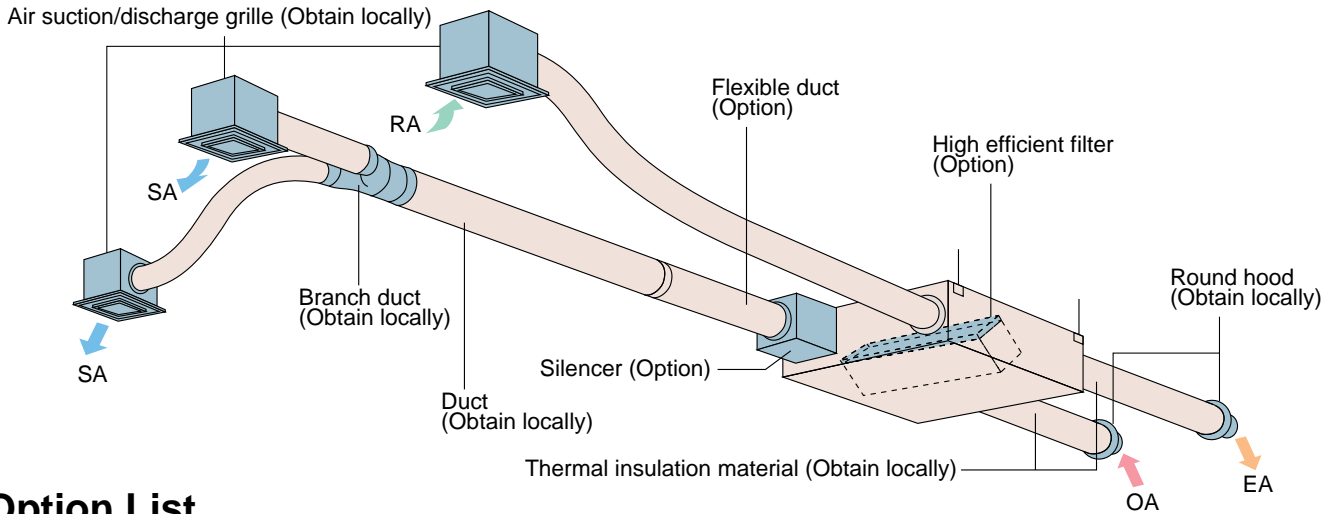

Option List

Item	Type	VAM150 · 250 · 350 · 500 · 650 · 800 · 1000 · 1500 · 2000 GJVE													
Controlling device	Heat Reclaim Ventilator remote controller	BRC301B61													
	Centralised controlling device	Residential central remote controller	DCS303A51 *1												
		Central remote controller	DCS302CA61												
		Unified ON/OFF controller	DCS301BA61												
		Schedule timer	DST301BA61												
	PC Board Adaptor	Wiring adaptor for electrical appendices	KRP2A61												
		For humidifier	KRP50-2												
		Installation box for adaptor PCB	KRP50-2A90 (Mounted electric component assy of Heat Reclaim Ventilator)												
		For heater control kit	BRP4A50												
		For wiring	Type (indoor unit of VRV)	FXFQ-P	FXZQ-M	FXCQ-M	FXKQ-MA	FXDQ-PB FXDQ-NB	FXSYQ-M	FXDYQ-M(A)	FXMQ-P	FXMQ-MA	FXHQ-MA	FXAQ-P	FXLQ-MA FXNQ-MA
			KRP1C63*	KRP1BA57*	KRP1B61*	KRP1B61	KRP1B56*	KRP1B61	KRP1C64*	KRP1B61	KRP1BA54	—	KRP1B61	—	
	Notes 2, 3 KRP1H98	Notes 4, 6 KRP1BA101	Notes 2, 3 KRP1B96	—	Notes 4, 6 KRP1BA101	Note 5 KRP4A91	—	Notes 2, 3 KRP4A96	—	Note 3 KRP1CA93	Notes 2, 3 KRP4AA93	—	KRP1BA97		

- Note: 1. Installation box ☆ is necessary for each adaptor marked ☆.
 2. Up to 2 adaptors can be fixed for each installation box.
 3. Only one installation box can be installed for each indoor unit.
 4. Up to 2 installation boxes can be installed for each indoor unit.
 5. Installation box ☆ is necessary for second adaptor.
 6. Installation box ☆ is necessary for each adaptor.
 7. *1 For residential use only. When connected with Heat Reclaim Ventilator (VAM), you can only switch the power ON/OFF. Cannot be used with other centralised control equipment.

Item	Type	VAM150GJVE	VAM250GJVE	VAM350GJVE	VAM500GJVE	VAM650GJVE	VAM800GJVE	VAM1000GJVE	VAM1500GJVE	VAM2000GJVE
Additional function	Silencer	—			KDDM24B50	KDDM24B100			KDDM24A100X2	
	Nominal pipe diameter mm	—			φ 200			φ 250		
	High efficiency filter	KAF242H25M		KAF242H50M		KAF242H65M	KAF242H80M	KAF242H100M	KAF242H80MX2	KAF242H100MX2
Air filter for replacement	KAF241G25M		KAF241G50M		KAF241G65M	KAF241G80M	KAF241G100M	KAF241G80MX2	KAF241G100MX2	
Flexible duct (1m)	K-FDS101D	K-FDS151D	K-FDS201D			K-FDS251D				
Flexible duct (2m)	K-FDS102D	K-FDS152D	K-FDS202D			K-FDS252D				
Duct adaptor	Nominal pipe diameter mm	—							YDFA25A1	φ 250

PC board adaptor for heater control kit (BRP4A50)

When the installation of an electric heater is required in a cold region, this adaptor with an internal timer function eliminates the complicated timer connecting work that was necessary with conventional heaters.

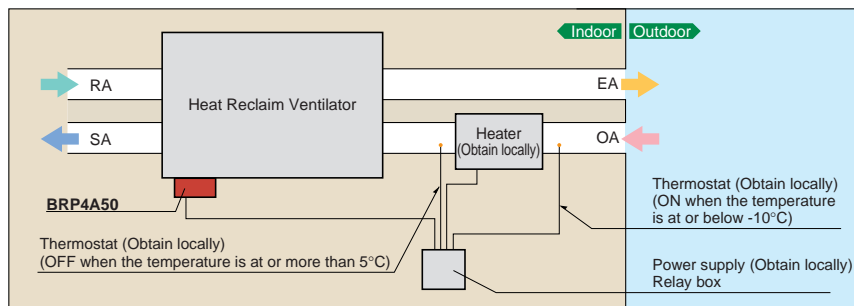

Notes when installing

- Examine fully an installation place and specification for using the electric heater based on the standard and regulation of each country.
- Supply the electric heater and safety production devices such as a relay and a thermostat, etc of which qualities satisfy the standard and regulation of each country at site.
- Use a non-inflammable connecting duct to the electric heater. Be sure to allow 2 m or more between the electric heater and Heat Reclaim Ventilator for safety.
- For the Heat Reclaim Ventilator units, use a different power supply from that of the electric heater and install a circuit breaker for each.

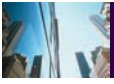



Warning



- Daikin products are manufactured for export to numerous countries throughout the world. Prior to purchase, please confirm with your local authorised importer, distributor and/or retailer whether this product conforms to the applicable standards, and is suitable for use, in the region where the product will be used. This statement does not purport to exclude, restrict or modify the application of any local legislation.
 - Ask a qualified installer or contractor to install this product. Do not try to install the product yourself. Improper installation can result in water or refrigerant leakage, electrical shock, fire or explosion and may have resultant impacts on warranty.
 - Use only those parts and accessories supplied or specified by Daikin. Ask a qualified installer or contractor to install those parts and accessories. Use of unauthorised parts and accessories or improper installation of parts and accessories can result in water or refrigerant leakage, electrical shock, fire or explosion.
 - Read the User's Manual carefully before using this product. The User's Manual provides important safety instructions and warnings. Be sure to follow these instructions and warnings.
- If you have any enquiries, please contact your local importer, distributor and/or retailer.

Cautions on product corrosion

1. Air conditioners should not be installed in areas where corrosive gases, such as acid gas or alkaline gas, are produced.
2. If the outdoor unit is to be installed close to the sea shore, direct exposure to the sea breeze should be avoided. If you need to install the outdoor unit close to the sea shore, contact your local distributor.



Organization:
DAIKIN INDUSTRIES, LTD.
AIR CONDITIONING MANUFACTURING
DIVISION

Scope of Registration:
THE DESIGN/DEVELOPMENT AND
MANUFACTURE OF COMMERCIAL AIR
CONDITIONING, HEATING, COOLING,
REFRIGERATING EQUIPMENT, HEATING
EQUIPMENT, RESIDENTIAL AIR
CONDITIONING EQUIPMENT, HEAT
RECLAIM VENTILATION, AIR CLEANING
EQUIPMENT, COMPRESSORS AND VALVES.

JMI-0107



Organization:
DAIKIN INDUSTRIES
(THAILAND) LTD.

Scope of Registration:
THE DESIGN/DEVELOPMENT
AND MANUFACTURE OF AIR
CONDITIONERS AND THE
COMPONENTS INCLUDING
COMPRESSORS USED FOR
THEM

JQA-1452



Quality
ISO 9001

Daikin Australia
Pty Limited (ISO9001)
QEC23256 May 31, 2006
Sydney, Brisbane, Adelaide,
Melbourne, Newcastle,
Townsville, Perth, Auckland



All of the Daikin
Group's business
facilities and
subsidiaries in Japan
are certified under the
ISO 14001
international standard
for environment
management.

EC99J2044



Environment
ISO 14001

Daikin Australia
Pty Limited (ISO14001)
CEM20437 October 27, 2006
Sydney, Brisbane, Melbourne,
Adelaide

Dealer

DAIKIN INDUSTRIES, LTD.

Head Office:
Umeda Center Bldg., 2-4-12, Nakazaki-Nishi,
Kita-ku, Osaka, 530-8323 Japan

Tokyo Office:
JR Shinagawa East Bldg., 2-18-1, Konan,
Minato-ku, Tokyo, 108-0075 Japan

http://www.daikin.com/global_ac/

© All rights reserved
Printed in Australia 07/12 Y.K.